

# AeroGuard

PLYMVENT

PLYMVENT

QUICK  
START  
MANUAL

PLYMVENT®





Before Using the AeroGuard, you must read and understand the [Use & Safety Guide](#)



## What's in the Box?

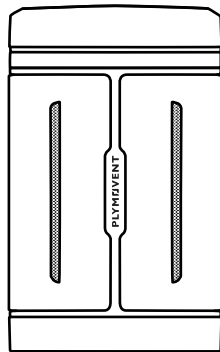

AeroGuard

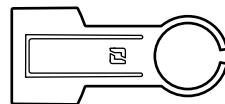

Wall Mount Connector

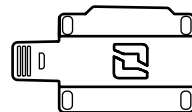

AeroGuard Dust Sensor

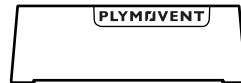

Wall Mount Base

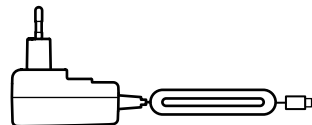

Regional Power Adapter



## Product Overview

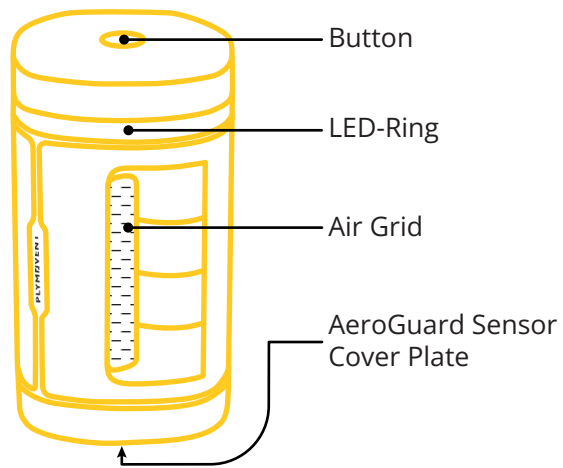

## ① Install the AeroGuard Dust Sensor

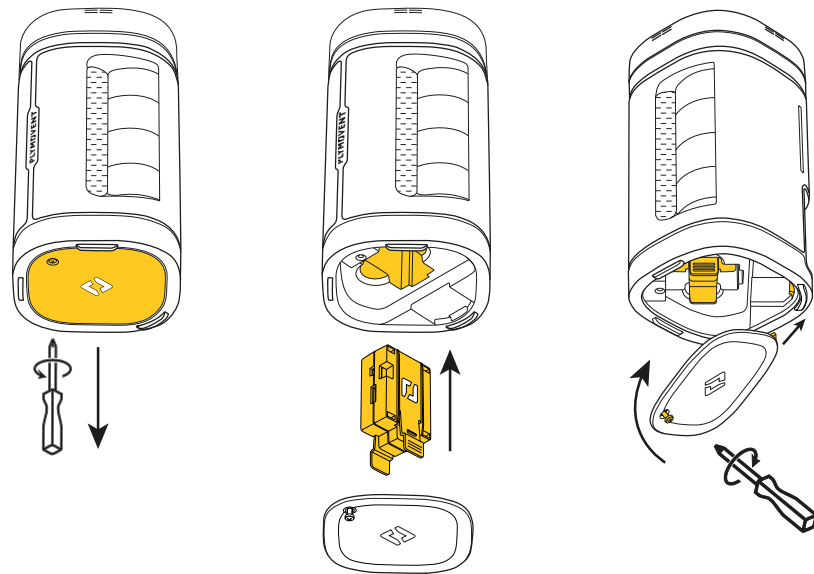



## Mounting Options

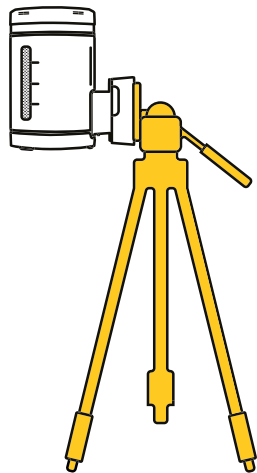
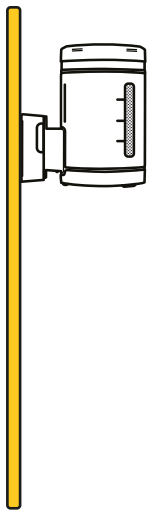

## Optional: Wall Mount

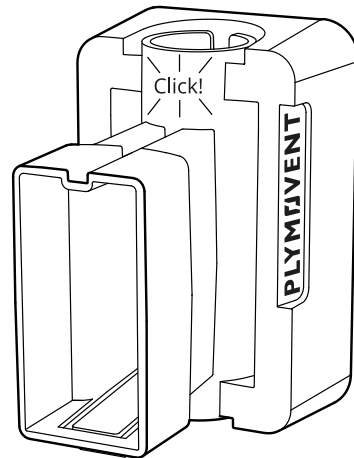
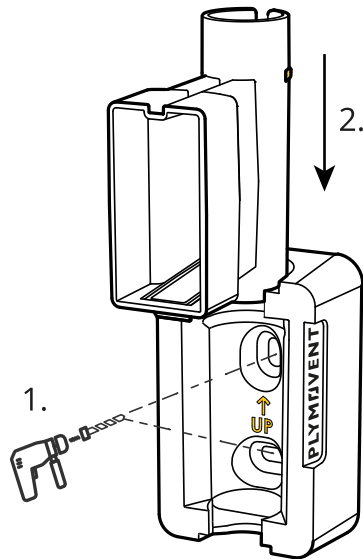

②

## Plug in the Power Adapter

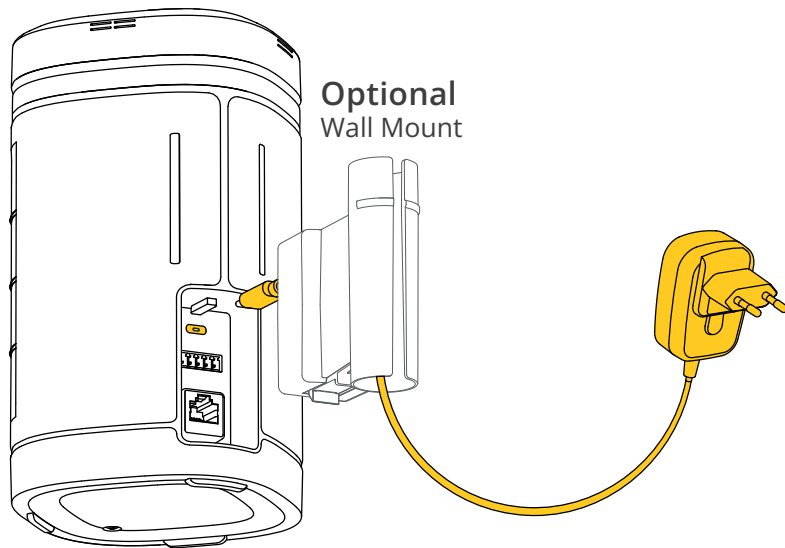

③

## Connect to the Internet

Setup with App  
(recommended)



Portal Only

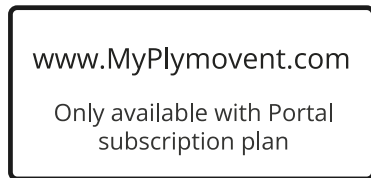
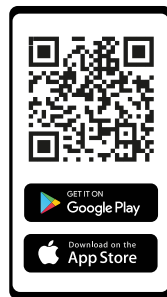

Follow the setup instructions  
in the AeroGuard App

Follow the setup instructions  
in the [MyPlymovent.com](http://MyPlymovent.com) Portal



## LED-Ring

Setup



White

Device Starting up

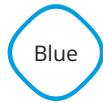

Blue

Ready to pair/configure

Use



Green

Good



Yellow

Fair



Red

Poor

LED-Indicates PM<sub>2.5</sub> by default

Customize

The LED-Ring shows the primary sensor readings.  
Change the primary sensors in the App & Portal.



## Sensor Measurements



**Dust Sensor**

Particulate matter  
PM<sub>1</sub> PM<sub>2.5</sub> PM<sub>4</sub> & PM<sub>10</sub>



**Temperature**

Temperature  
in °C and °F



**VOC**

Total Volatile Organic  
Compounds in mg/m<sup>3</sup>



**Sound**

Sound levels  
L<sub>Aeq</sub> in dB



**Humidity**

Relative humidity  
in %RH



**Atmospheric Pressure**

Atmospheric pressure  
in hPa



**IAQ Index**

Indoor Air Quality index  
with UBA standard



**Carbon Dioxide**

CO<sub>2</sub> levels  
in ppm

4

## Relay Outputs

### Custom Settings

The LED-Ring shows the measurements of one sensor. Change which sensor data is shown on the LED-Ring in the App & Portal.

Customize relay settings with the Portal subscription plan.

### Default Settings

PM <sub>2.5</sub> ( $\mu\text{g}/\text{m}^3$ )	Good <1000	Fair 1000 - 2000	Poor >2000
Relay 1	Off	On	On
Relay 2	Off	Off	On

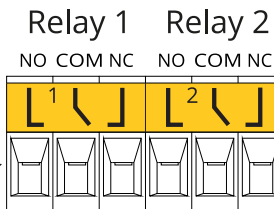
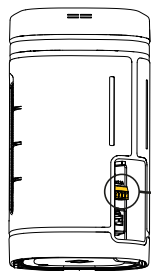

Max. 30 V (AC/DC), 2 A

Wire an external application to COM (common) in combination with NO (normally open) or NC (normally closed).

5

## Calibration

To get the most accurate readings for your use, review and change the calibrations options in the App or Portal.

### Particulate Matter (Dust) Sensor Options



**Default Calibration**  
General dust calibration (factory settings) for home and office.



**General Exhaust Fumes**  
Calibrated to best reflect dust particles in exhaust emissions.



**General Welding Fumes**  
Calibrated to best reflect dust particles in welding bays.



**Custom Calibration**  
Create your own dust calibration. (Portal subscription only)

### Other Calibration Options



**Carbon Dioxide**  
Automatic (default) or custom settings available.



**Relative Humidity**  
Offset in %RH available.



**Temperature**  
Offset in °C and °F available.



## Spare Parts & Accessories

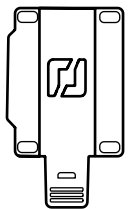

A

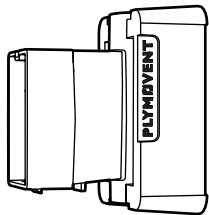

B

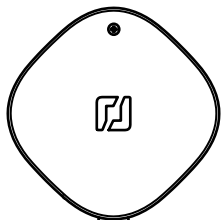

C

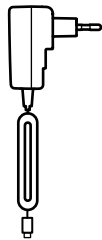

D

A	AeroGuard Dust Sensor	0000304925
B	AeroGuard Wall Mount	0000305091
C	AeroGuard Sensor Cover Plate	0000305092
D	AeroGuard Global Power Adapter	0000304991



