

FUA (60Hz)

FUA-1800/2100/2700/3000/4700

The FUA is an extraction fan that is specially designed to remove exhaust gases, as well as welding and other fumes, dust and oil mist.

The fan is intended and designed for mounting to extraction arms, filter units and vehicle exhaust extraction systems or can be used as a central fan. The fan is rated for outdoor use.



APPLICATIONS

The FUA fans are intended to be used for the following applications:

- MIG-MAG/GMAW welding
- TIG welding
- FCAW welding
- stick/MMAW welding
- vehicle exhaust extraction systems



Do **not** use the FUA fans for the following applications or in the following circumstances:

- aluminium laser cutting
- extraction of aggressive fumes and gases (e.g. from acids, alkaline or soldering paste containing lithium)
- extraction of hot gases exceeding 176°F (80°C) continuously
- grinding aluminium and magnesium
- flame spraying
- extraction of cement, saw dust, wood dust, etc.
- explosive environments or explosive substances/gases



SPECIFICATIONS

Physical dimensions and properties

Material:	<ul style="list-style-type: none"> • impeller (non-ferrous) • housing 	<ul style="list-style-type: none"> • aluminium • powder coated galvanized sheet metal
Color of housing	basalt grey (RAL 7011)	
Motor design	NEMA	
Fan type	centrifugal	
Impeller	backward inclined	
Design conditions	68°F (20°C) at sea level	
Max. airflow temperature	176°F (80°C) continuously	
Performance		
Max. starts/stops per hour	20 (1ph); 30 (3ph)	
Ambient conditions		
Operating temperature:	<ul style="list-style-type: none"> • min. • nom. • max. 	<ul style="list-style-type: none"> • -4°F (-20°C) • 68°F (20°C) • 176°F (80°C)
Max. relative humidity	80%	
Storage conditions	<ul style="list-style-type: none"> • -4 to 176°F (-20 to 80°C) • relative humidity max. 80% 	

Options and accessories

Universal mounting bracket for freestanding, wall, or ceiling mounting

- | | |
|-------------|----------------------|
| • MB-FUA/S1 | • FUA-1800/2100/2700 |
| • MB-FUA/S2 | • FUA-3000/4700 |

Mounting bracket to mount the fan on a FlexMax extension crane, UK extractor crane or FEB boom arm

- | | |
|-------------|----------------------|
| • MB-FUA/C1 | • FUA-1800/2100/2700 |
| • MB-FUA/C2 | • FUA-3000/4700 |

Outlet transition from rectangular to round

- | | |
|-------------------|------------|
| • OL-250/FUA-3000 | • FUA-3000 |
| • OL-250/FUA-4700 | • FUA-4700 |
| • OL-315/FUA-4700 | • FUA-4700 |

Soft connection

- | | |
|----------|---------------------------|
| • SC-160 | • FUA-1800/2100/2700 |
| • SC-250 | • FUA-3000/4700 (+OL-250) |

Scope of supply

Extraction fan

Shipping data

Harmonized Tariff Code	8414.5940.90
Number/package	1

APPROVALS/CERTIFICATES

	<p>FUA-1800/2100/2700: compliance with CE directives</p> <p>FUA-3000/4700: compliance with CE directives as part of an installation</p>
	Directive 2011/65/EC (RoHS) valid as of 8 June 2011
	Plymovent certifies that the products shown herein are licensed to bear the AMCA Seal. The ratings shown comply with the requirements of the AMCA Certified Ratings Program. FUA fans are rated AMCA Type B
	Certified motor
	Certified motor

ARTICLE NUMBERS, WEIGHTS AND PACKING DIMENSIONS

Fan type	Connection voltage	Article number	Weight		Packing dimensions
			Net	Gross*	
FUA-1800	115/208-230V/1ph/60Hz	0000102912	66.1 lbs	72.8 lbs	22.4 x 22.0 x 16.5 in. (56,9 x 55,9 x 40,6 cm)
	208-230/460V/3ph/60Hz	0000102913	51.8 lbs	56.2 lbs	18.5 x 18.5 x 20.9 in. (47 x 47 x 53 cm)
	575V/3ph/60Hz	0000102914	51.8 lbs	56.2 lbs	18.5 x 18.5 x 20.9 in. (47 x 47 x 53 cm)
FUA-2100	115/208-230V/1ph/60Hz	0000102916	67.7 lbs	68.3 lbs	22.4 x 22.0 x 16.5 in. (56,9 x 55,9 x 42 cm)
	208-230/460V/3ph/60Hz	0000102917	54.0 lbs	58.4 lbs	18.5 x 18.5 x 20.9 in. (47 x 47 x 53 cm)
	575V/3ph/60Hz	0000102918	54.0 lbs	58.4 lbs	18.5 x 18.5 x 20.9 in. (47 x 47 x 53 cm)
FUA-2700	115/208-230V/1ph/60Hz	0000102919	68.3 lbs	76.1 lbs	22.4 x 22.0 x 16.5 in. (56,9 x 55,9 x 42 cm)
	208-230/460V/3ph/60Hz	0000102920	60.6 lbs	65.0 lbs	18.5 x 18.5 x 20.9 in. (47 x 47 x 53 cm)
	575V/3ph/60Hz	0000102921	60.6 lbs	65.0 lbs	18.5 x 18.5 x 20.9 in. (47 x 47 x 53 cm)
FUA-3000	115/208-230V/1ph/60Hz	0000102922	87.1 lbs	93.7 lbs	23.2 x 23.6 x 23.6 in. (59 x 60 x 60 cm)
	208-230/460V/3ph/60Hz	0000102923	72.8 lbs	80.5 lbs	23.6 x 23.6 x 19.3 in. (60 x 60 x 49 cm)
	575V/3ph/60Hz	0000103156	72.8 lbs	80.5 lbs	23.6 x 23.6 x 19.3 in. (80 x 55,9 x 49 cm)
FUA-4700	208-230V/1ph/60Hz	0000102924	90.4 lbs	99.2 lbs	31.1 x 23.2 x 25.6 in. (79 x 59 x 65 cm)
	208-230/460V/3ph/60Hz	0000102925	90.4 lbs	99.2 lbs	31.1 x 23.2 x 25.6 in. (79 x 59 x 65 cm)
	575V/3ph/60Hz	0000102926	90.4 lbs	99.2 lbs	31.1 x 23.2 x 25.6 in. (79 x 59 x 65 cm)

*Gross weight = including packaging

DIMENSIONS

FUA-1800/2100/2700

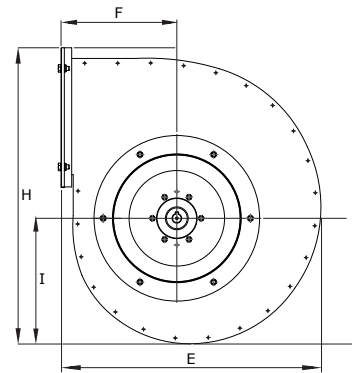
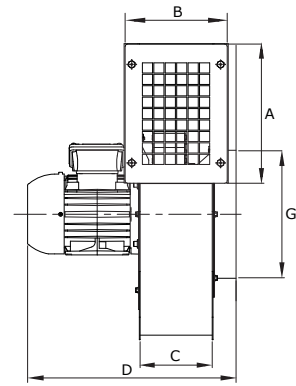
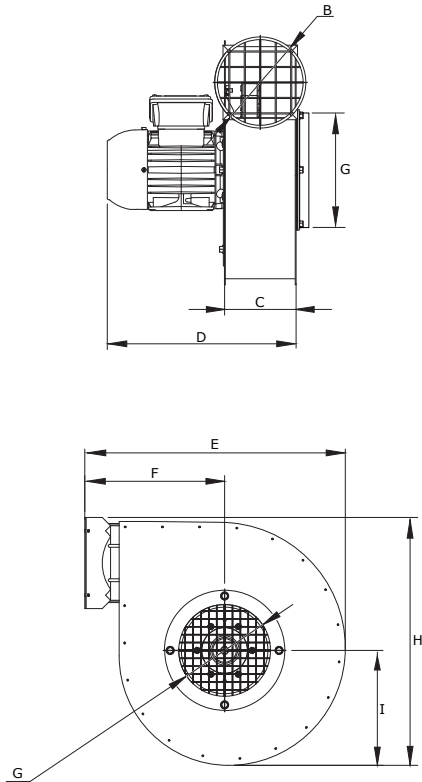

	FUA-1800		FUA-2100		FUA-2700		FUA-3000		FUA-4700	
	inch	mm	inch	mm	inch	mm	inch	mm	inch	mm
A	-	-	-	-	-	-	10.8	275	13.7	348
B	Ø 6.3	Ø 159	Ø 6.3	Ø 159	Ø 6.3	Ø 159	5.5	140	5.5	140
C	4.9	125	4.9	125	4.9	125	5.7	145	5.7	145
D	1~ motor 3~ motor	15.9 14.8	403 375	16.9 14.8	430 375	15.8 400	19.3 18.1	489 459	20.0 18.8	508 478
E	17.9	455	17.9	455	17.9	455	20.2	512	23.3	591
F	9.6	244	9.6	244	9.6	244	9.0	228	10.2	258
G	Ø 6.3	Ø 160	Ø 6.3	Ø 160	Ø 6.3	Ø 160	Ø 9.8	Ø 250	Ø 9.6	Ø 245
H	17.1	433	17.1	433	17.1	433	23.0	583	28.9	733
I	7.9	201	7.9	201	7.9	201	9.7	247	11.7	297

POSSIBLE OUTLET POSITIONS

FUA-1300/1800/ 2100/2700/3000

FUA-4700

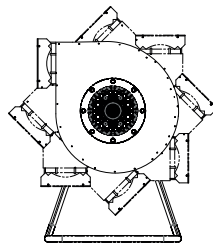
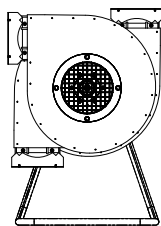
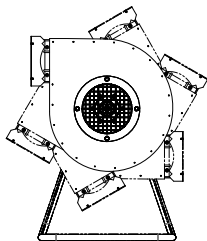

60° or multiple

90°

45° or multiple

PRESSURE DROP FUA-1800 | FUA-2100

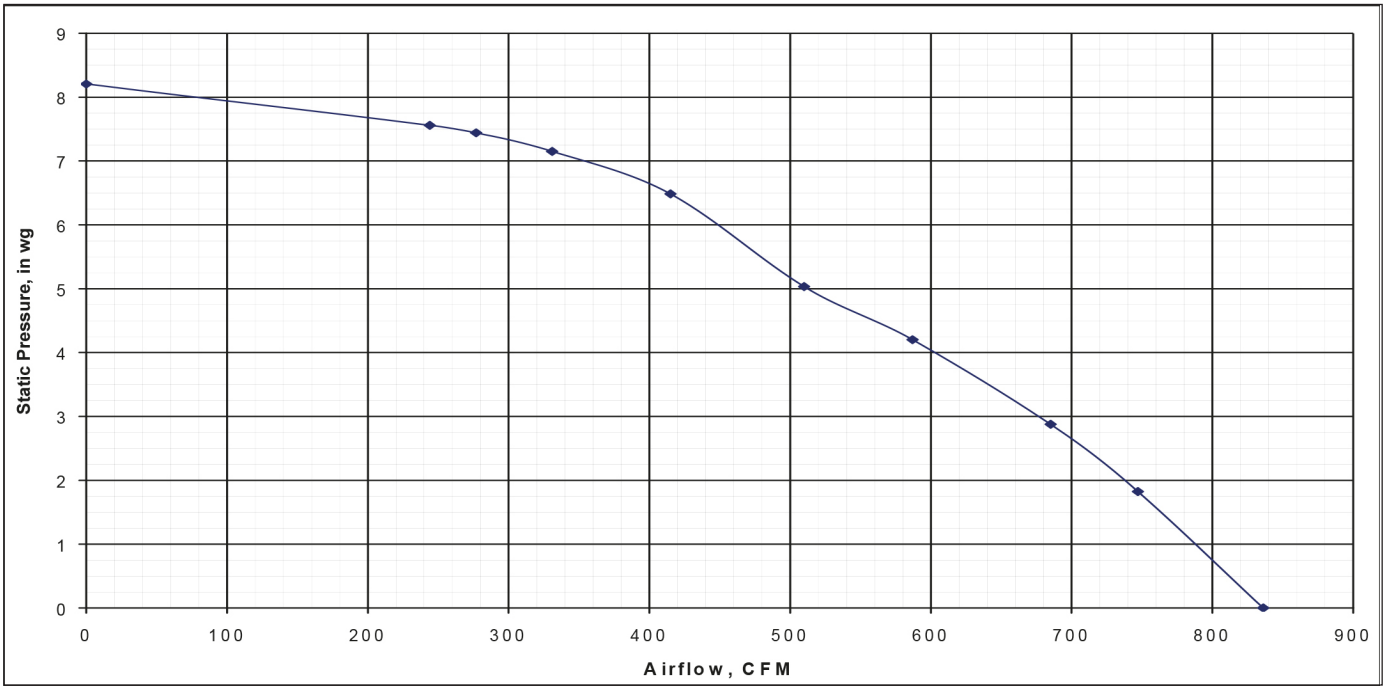

FUA-1800

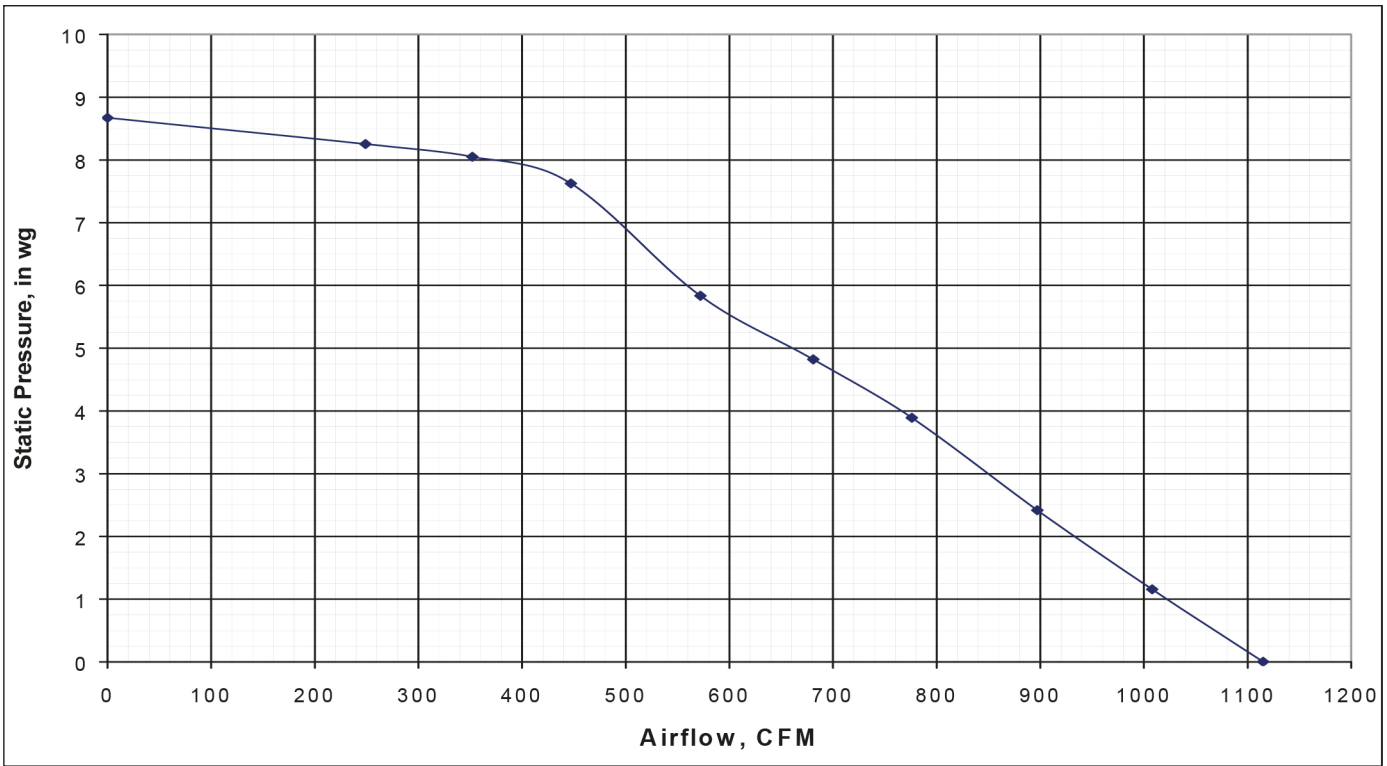

FUA-2100

PRESSURE DROP FUA-2700 | FUA-3000

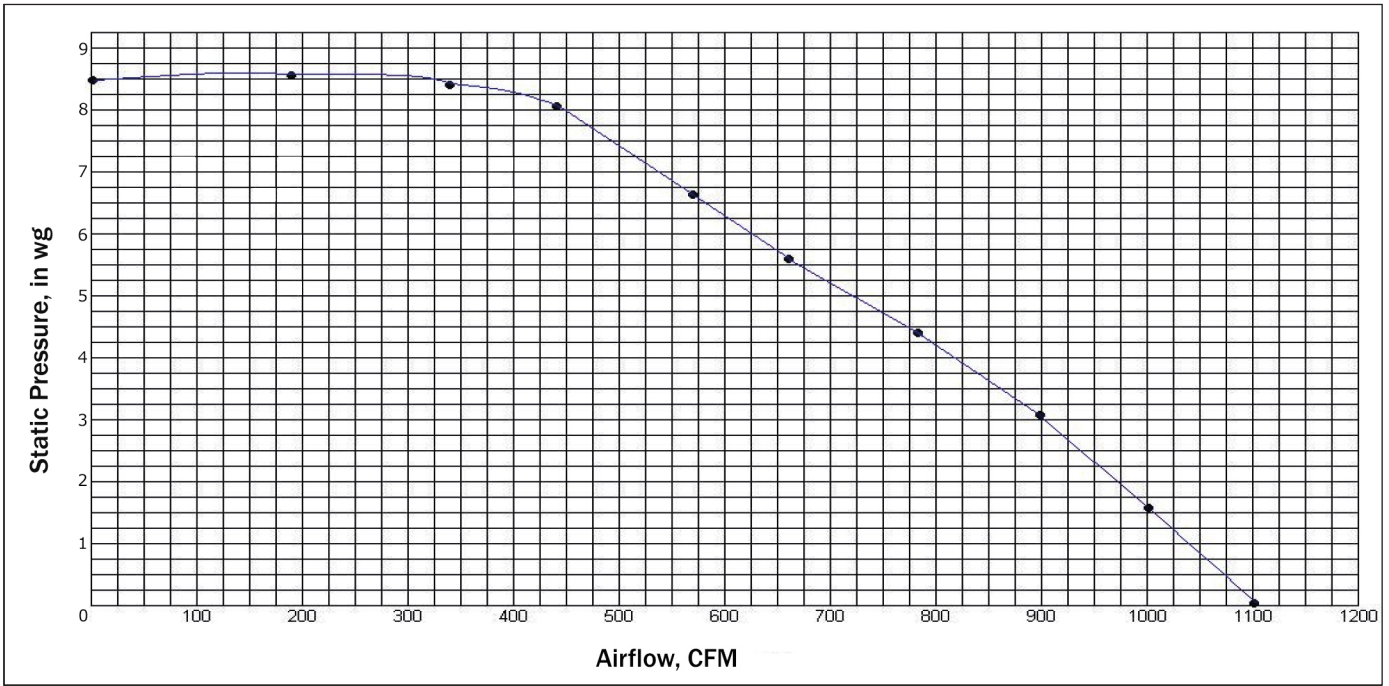

FUA-2700

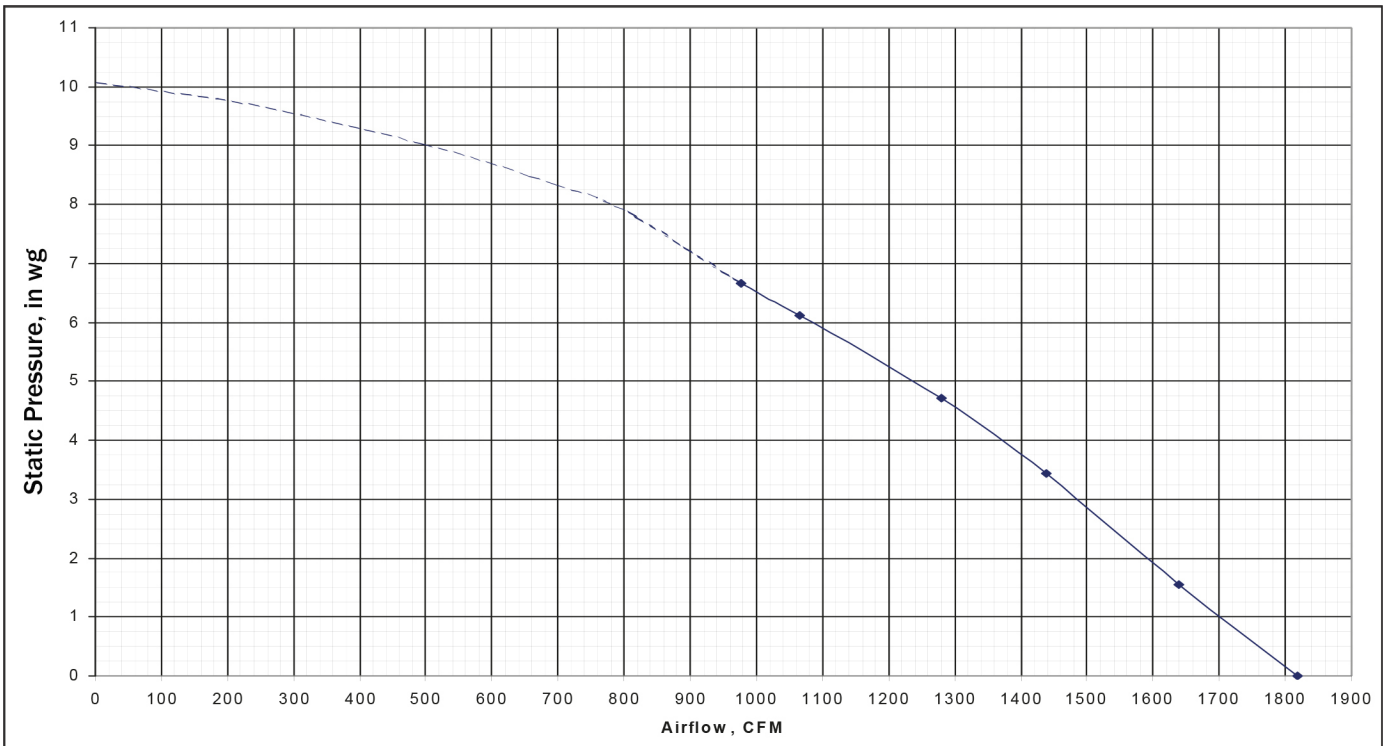

FUA-3000

PRESSURE DROP FUA-4700

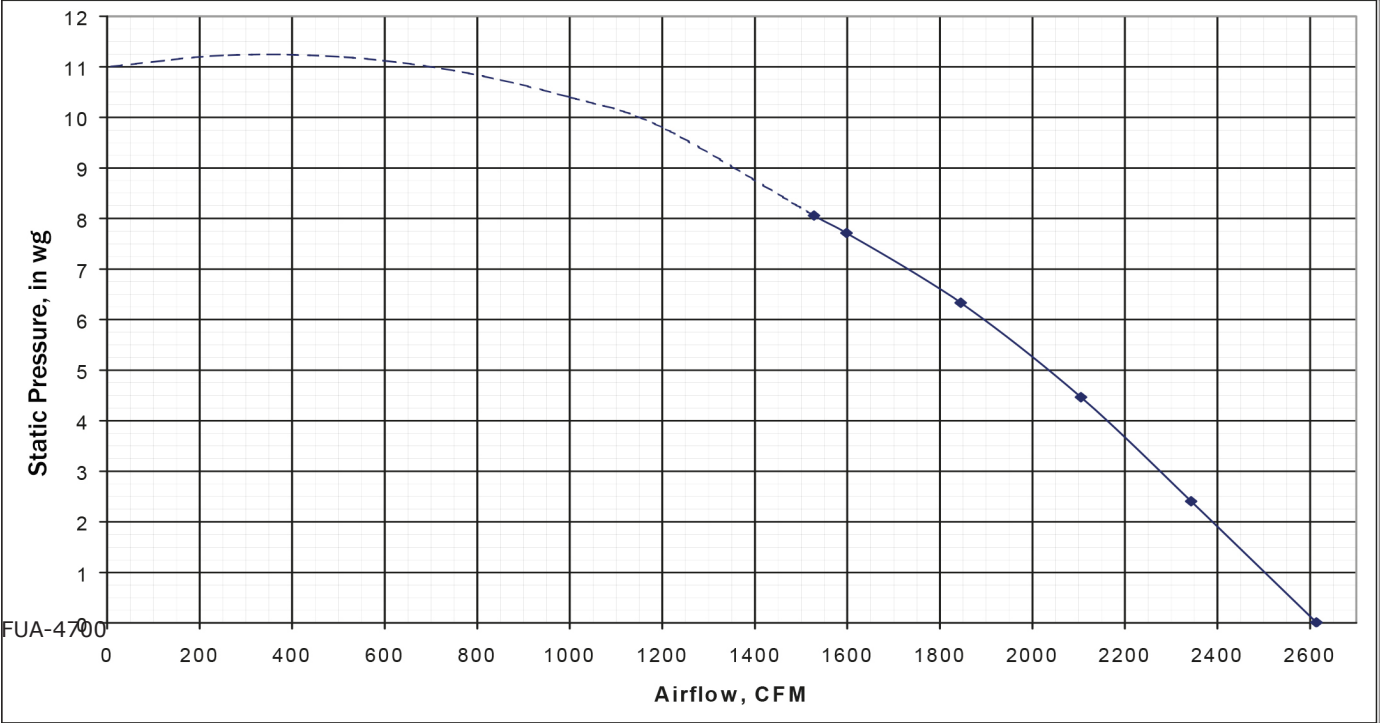

NOISE LEVEL

Sub table A: Sound power levels (L_w) in dB

Sound power is a measure of sound energy per time unit. For a sound source, unlike sound pressure, sound power is neither room dependent nor distance dependent. Sound power is a theoretical value that is not measurable. It is calculated and expressed in watts and as sound power level L_w in decibels.

The table below shows the sound power levels in dB calculated according to AMCA Standard 301.

	Static pressure (in. WG)	Airflow (CFM)	Octave band number & center frequency number (Hz)							
			1	2	3	4	5	6	7	8
			63	125	250	500	1000	2000	4000	8000
FUA-1800	0	836	109	100	91	91	87	86	82	76
	2.4	715	105	98	89	88	83	83	78	71
	4.8	530	100	99	87	86	81	80	74	68
	7.15	331	104	97	81	82	79	76	70	65
FUA-2100	0	1115	97	98	91	93	88	88	83	80
	2.5	890	90	95	91	93	86	84	79	75
	5	660	95	96	89	90	84	81	75	71
	7.62	447	88	94	89	89	83	79	72	70
FUA-2700	0	1107	78	88	90	89	86	84	83	80
	2.95	900	79	87	89	87	85	81	79	74
	5.35	700	83	84	88	84	83	79	76	71
	7.75	500	80	82	88	87	85	79	74	70
FUA-3000	0	1818	89	91	97	99	94	90	84	81
	2.2	1570	95	91	98	100	91	87	81	78
	4.4	1320	88	90	98	96	88	84	78	75
	6.66	977	89	91	95	94	86	82	75	72
FUA-4700	0	2614	99	93	92	93	92	91	87	86
	2.4	2343	98	95	94	93	92	90	85	83
	5	2040	98	95	93	92	89	87	82	80
	8.05	1528	95	92	96	91	86	85	80	77

Sub table B: Conversion of sound power level (L_w) to sound pressure level (L_p)

A sound source produces sound power, which generates a sound pressure fluctuation in the air. Sound power is the distance-independent cause of this, whereas sound pressure is the distance-dependent effect.

The table below shows the dB value to be deduced from the values of sub table A to achieve the sound pressure level at a certain distance.

	Sound pressure level			
At a distance of:	1 m (3.3 ft)	2 m (6.5 ft)	3 m (9.8 ft)	4 m (13.1 ft)
Ref.: sound power levels (L_w) in sub table A	-11 dB	-17 dB	-21 dB	-23 dB

Sub table C: A-weighting of sound pressure level

The most common weighting that is used in noise measurement is A-weighting. Like the human ear, this effectively cuts off the lower and higher frequencies that the average person cannot hear.

The table below shows the A-weighting related to the different frequencies.

Octave band number	1	2	3	4	5	6	7	8
Frequency (Hz)	63	125	250	500	1000	2000	4000	8000
A-weighting	-0.8	-0.2	0	0	0	-0.2	-0.8	-3.0

Note: dB(A) levels are not licensed by AMCA International.

MOTOR SPECIFICATIONS FUA-1800 | FUA-2100 | FUA-2700

	FUA-1800			FUA-2100			FUA-2700		
Power	0.75 HP (0,55 kW)			1 HP (0,75 kW)	1 HP (0,75 kW)		1.5 HP (1,1 kW)		
Energy efficiency (NEMA)	standard			standard	premium		premium		
Rated voltage	115/208-230V	208-230/460V	575V	115/208-230V	208-230/460V	575V	115/208-230V	208-230/460V	575V
No. of phases	1ph	3ph	3ph	1ph	3ph	3ph	1ph	3ph	3ph
Frequency	60Hz	60Hz	60Hz	60Hz	60Hz	60Hz	60Hz	60Hz	60Hz
Frame	56C	56C	56C	56C	56C	56C	56C	56C	56C
Poles	2	2	2	2	2	2	2	2	2
Rated speed	3450 rpm	3450 rpm	3475 rpm	3450 rpm	3480 rpm	3480 rpm	3450 rpm	3490 rpm	3460 rpm
Slip	Unlisted	Unlisted	3.47%	Not Listed	Not Listed	3.47%	Unlisted	Unlisted	3.89%
Rated current	10/5.2-5 A	2.5-2.4/1.2 A	0.904 A	11.8/6.1-5.9 A	3.0-2.8/1.4 A	1.2 A	17/8.7-8.5 A	4.4-4.2/2 A	1.62 A
L. R. Amperes	30 A	7.3 A @460V	6.33 A	64.40 A	26.00 A @460V	13.1 A	133/66.8 A	34.0/17.0 A	13.6 A
ll/In	Unlisted	Unlisted	Unlisted	Not Listed	Not Listed	Not Listed	Unlisted	Unlisted	Unlisted
No load current	2.93 @230V	.75A @460V	0.440 A	4.5 A @ 230 V	0.95 A @460V	0.829 A	4.67 A @230V	1.00 A @460V	0.652 A
Rated torque	18.00 ft-lbs (24.40 Nm)	18.00 ft-lbs (24.40 Nm)	1.12 ft-lbs (1.51 Nm)	3.00 ft-lbs (4.07 Nm)	3.02 ft-lbs (4.09 Nm)	1.49 ft-lbs (2.02 Nm)	2.25 ft-lbs (3.05 Nm)	2.25 ft-lb (3.05 Nm)	2.25 ft-lb (3.05 Nm)
Locked rotor torque	356%	256%	250%	250%	360%	229%	240%	378%	240%
Breakdown torque	267%	361%	290%	260%	433%	380%	270%	498%	270%
Design		N	B	L	L	A		B	B
Insulation class	N	B	F	F	F	F	L	F	F
Temperature rise		57 @100% load	80 K	90 @100% load	46 @100% load	80 @100% Load		46.0 @100%	80 K
Locked rotor time	Unlisted	22 s (hot)	23 s (hot)	90.0 F @FL	17 s (hot)	11 s (hot)	Unlisted	Unlisted	21 s (hot)
Service factor	1.15 / 1	1 / 1.15	1.15	1.15 / 1	1 / 1.15	1.15	1.15 / 1	1 / 1.15	1.15
Duty cycle	Continuous	Continuous	Continuous	Continuous	Continuous	Continuous	Continuous	Continuous	Continuous
Ambient temperature	-4°F to 76°F (-20°C to +80°C)	-4°F to 76°F (-20°C to +80°C)	-4°F to 76°F (-20°C to +80°C)	-4°F to 76°F (-20°C to +80°C)	-4°F to 76°F (-20°C to +80°C)	-4°F to 76°F (-20°C to +80°C)	-4°F to 76°F (-20°C to +80°C)	-4°F to 76°F (-20°C to +80°C)	-4°F to 76°F (-20°C to +80°C)
Altitude	3280 ft (1000 m) above sea level	3280 ft (1000 m) above sea level	3280 ft (1000 m) above sea level	3280 ft (1000 m) above sea level	3280 ft (1000 m) above sea level	3280 ft (1000 m) above sea level	3280 ft (1000 m) above sea level	3280 ft (1000 m) above sea level	3280 ft (1000 m) above sea level
Enclosure	IP43 (TEFC)	IP54 (TEFC)	IP55 (TEFC)	IP43 (TEFC)	IP43 (TEFC)	IP55 (TEFC)	IP43 (TEFC)	IP43 (TEFC)	IP55 (TEFC)
Mounting	Rigid/R1	Rigid/R1	Rigid/R1	Rigid/F1	Rigid/F1	Rigid/F1	Rigid/R1	Rigid/R1	B34T
Rotation	both	both	both	both	both	both	both	both	both
Preferred preset rotation direction	CCW, seen from drive end side			CCW, seen from drive end side			CCW, seen from drive end side		
Approx. weight	29 lbs (13.15 kg)	22.00 lbs (9.98 kg)	20.90 lbs (9.48 kg)	45 lb (20,41 kg)	35 lb (15,88 kg)	32.3 lb (14,65 kg)	37 lbs (16.78 kg)	32 lbs (14.52 kg)	27.10 lbs (12.29 kg)
Moment of inertia	0.0020 kgm ²	0.0014 kgm ²	0.0014 kgm ²	Not Listed	Not Listed	0.0963 sq.ft. lb (0,0133 kgm ²)	0.0023 kgm ²	0.0020 kgm ²	0.0020 kgm ²
Sound pressure level (global)	Unlisted	Unlisted	68.0 dB(A)	Not Listed	Not Listed	68.0 dB(A)	Unlisted	Unlisted	68.0 dB(A)
Foundation loads: • max. traction • max. compression	Unlisted	Unlisted	Unlisted	Unlisted	Unlisted	Unlisted	Unlisted	Unlisted	250 N 431 N
Load: 100% • Power factor • Efficiency	76.3% 64%	75.6% 78.4 %	85% 72%	87.0% 73%	87.1% 88.4%	90.0% 80.0%	80% 72%	82.2% 84.6%	90% 77%
Load: 75% • Power factor • Efficiency	73% 58.6%	70.6% 73.5%	79% 68%	81.7% 72.9%	86.7 % 82.1%	86% 78.5%	73.5% 70.5%	76.3% 82.2%	0.82 84.0%
Load: 50% • Power factor • Efficiency	65.4% 50.3%	58.9% 68.3%	70% 62%	71.8% 71%	85.5% 72.2%	76% 75.5%	66.1% 62.7%	64.7% 79.1%	76% 72%

MOTOR SPECIFICATIONS FUA-3000 | FUA-4700

	FUA-3000			FUA-4700		
Power	2 HP (1,5 kW)			3 HP (2,2 kW)		
Energy efficiency (NEMA)	standard			premium		
Rated voltage	115/208-230V	208-230/ 460V	575V	208-230V	208-230/ 460V	575V
No. of phases	1ph	3ph	3ph	1ph	3ph	3ph
Frequency	60Hz	60Hz	60Hz	60Hz	60Hz	60Hz
Frame	56C	56C	56C	145T	56C	56C
Poles	2	2	2	2	2	2
Rated speed	3450 rpm	3490 rpm	3600 rpm	3450 rpm	3490 rpm	3480 rpm
Slip	Unlisted	Unlisted	3.06%	2.78%	3.89%	3.33%
Rated current	20/11.4-10 A	5.2-4.8/2.4 A	2.00 A	14.38-13 A	8.8-8/4 A	3.01 A
L. R. Amperes	64.40 A	34.0/17.0 A	16.1 A	100 A @230V	41 A @460V	25.6 A
II/In	9.4 Code M	8.9 Code L	8.9 Code L	7.0 Code J	8.1 Code J	8.1 Code J
No load current	8.00/4.00 A	1.50/0.750 A	0.600 A	5.30/2.65 A	3.08/1.54 A	1.12 A
Rated torque	3.02 Nm	3.06 Nm	3.06 Nm	6.10 Nm	6.17 Nm	6.17 Nm
Locked rotor torque	250%	350%	350%	210%	330%	330%
Breakdown torque	310%	380%	380%	230%	360%	360%
Design		B	B		B	B
Insulation class	F	F	F	F	F	F
Temperature rise		80 K	80 K		80 K	80 K
Locked rotor time	8 s (hot)	21 s (hot)	21 s (hot)	8 s (hot)	14 s (hot)	14 s (hot)
Service factor	1.15	1.25	1.25	1.15	1.25	1.25
Duty cycle	S1	S1	S1	S1	S1	S1
Ambient temperature	-4°F to 176°F (-20°C to +80°C)	-4°F to 176°F (-20°C to +80°C)	-4°F to 176°F (-20°C to +80°C)	-4°F to 176°F (-20°C to +80°C)	-4°F to 176°F (-20°C to +80°C)	-4°F to 176°F (-20°C to +80°C)
Altitude	1000 m (3280 ft) above sea level	1000 m (3280 ft) above sea level	1000 m (3280 ft) above sea level	1000 m (3280 ft) above sea level	1000 m (3280 ft) above sea level	1000 m (3280 ft) above sea level
Enclosure	IP55 (TEFC)	IP55 (TEFC)	IP55 (TEFC)	IP55 (TEFC)	IP55 (TEFC)	IP55 (TEFC)
Mounting	B34T	B34T	B34T	B34T	B34T	B34T
Rotation	both	both	both	both	both	both
Preferred preset rotation direction	CCW, seen from drive end side			CCW, seen from drive end side		
Approx. weight	26.0 kg (57.3 lbs)	18.5 kg (40.8 lbs)	18.5 kg (40.8 lbs)	27.9 kg (61.5 lbs)	23.5 kg (51.8 lbs)	23.5 kg (51.8 lbs)
Moment of inertia	0.0023 kgm ²	0.0020 kgm ²	0.0020 kgm ²	0.0028 kgm ²	0.0026 kgm ²	0.0026 kgm ²
Sound pressure level (global)		68.0 dB(A)	68.0 dB(A)		68.0 dB(A)	68.0 dB(A)
Foundation loads: • max. traction • max. compression		250 N 431 N	250 N 431 N	274 N 548 N	55 kgf 78 kgf	536 N 766 N
Load: 100% • Power factor • Efficiency	0.88 76.4%	0.86 84.0%	0.86 84.0%	0.90 79.0%	0.86 86.5%	0.86 86.5%
Load: 75% • Power factor • Efficiency	0.86 75.5%	0.82 84.0%	0.82 84.0%	0.87 78.5%	0.81 86.5%	0.81 86.5%
Load: 50% • Power factor • Efficiency	0.83 74.3%	0.72 81.5%	0.72 81.5%	0.79 75.0%	0.70 85.5%	0.70 85.5%

MOTOR SPECIFICATIONS FUA-3000 | FUA-4700

	FUA-3000			FUA-4700		
Power	2 HP (1,5 kW)			3 HP (2,2 kW)		
Energy efficiency (NEMA)	standard			premium		
Rated voltage	115/208-230V	208-230/ 460V	575V	208-230V	208-230/ 460V	575V
No. of phases	1ph	3ph	3ph	1ph	3ph	3ph
Frequency	60Hz	60Hz	60Hz	60Hz	60Hz	60Hz
Frame	56C	56C	56C	145T	56C	56C
Poles	2	2	2	2	2	2
Rated speed	3450 rpm	3490 rpm	3600 rpm	3450 rpm	3490 rpm	3480 rpm
Slip	Unlisted	Unlisted	3.06%	2.78%	3.89%	3.33%
Rated current	20/11.4-10 A	5.2-4.8/2.4 A	3.10 A	14.38-13 A	8.8-8/4 A	3.01 A
L. R. Amperes	64.40 A	34.0/17.0 A	16.1 A	100 A @230V	41 A @460V	25.6 A
ll/ln	9.4 Code M	8.9 Code L	8.9 Code L	7.0 Code J	8.1 Code J	8.1 Code J
No load current	8.00/4.00 A	1.50/0.750 A	0.600 A	5.30/2.65 A	3.08/1.54 A	1.12 A
Rated torque	3.02 Nm	3.06 Nm	3.06 Nm	6.10 Nm	6.17 Nm	6.17 Nm
Locked rotor torque	250%	350%	350%	210%	330%	330%
Breakdown torque	310%	380%	380%	230%	360%	360%
Design		B	B		B	B
Insulation class	F	F	F	F	F	F
Temperature rise		80 K	80 K		80 K	80 K
Locked rotor time	8 s (hot)	21 s (hot)	21 s (hot)	8 s (hot)	14 s (hot)	14 s (hot)
Service factor	1.15	1.25	1.25	1.15	1.25	1.25
Duty cycle	S1	S1	S1	S1	S1	S1
Ambient temperature	-4°F to 176°F (-20°C to +80°C)	-4°F to 176°F (-20°C to +80°C)	-4°F to 176°F (-20°C to +80°C)	-4°F to 176°F (-20°C to +80°C)	-4°F to 176°F (-20°C to +80°C)	-4°F to 176°F (-20°C to +80°C)
Altitude	1000 m (3280 ft) above sea level	1000 m (3280 ft) above sea level	1000 m (3280 ft) above sea level	1000 m (3280 ft) above sea level	1000 m (3280 ft) above sea level	1000 m (3280 ft) above sea level
Enclosure	IP55 (TEFC)	IP55 (TEFC)	IP55 (TEFC)	IP55 (TEFC)	IP55 (TEFC)	IP55 (TEFC)
Mounting	B34T	B34T	B34T	B34T	B34T	B34T
Rotation	both	both	both	both	both	both
Preferred preset rotation direction	CCW, seen from drive end side			CCW, seen from drive end side		
Approx. weight	26.0 kg (57.3 lbs)	18.5 kg (40.8 lbs)	18.5 kg (40.8 lbs)	27.9 kg (61.5 lbs)	23.5 kg (51.8 lbs)	23.5 kg (51.8 lbs)
Moment of inertia	0.0023 kgm ²	0.0020 kgm ²	0.0020 kgm ²	0.0028 kgm ²	0.0026 kgm ²	0.0026 kgm ²
Sound pressure level (global)		68.0 dB(A)	68.0 dB(A)		68.0 dB(A)	68.0 dB(A)
Foundation loads: • max. traction • max. compression		250 N 431 N	250 N 431 N	274 N 548 N	55 kgf 78 kgf	536 N 766 N
Load: 100% • Power factor • Efficiency	0.88 76.4%	0.86 84.0%	0.86 84.0%	0.90 79.0%	0.86 86.5%	0.86 86.5%
Load: 75% • Power factor • Efficiency	0.86 75.5%	0.82 84.0%	0.82 84.0%	0.87 78.5%	0.81 86.5%	0.81 86.5%
Load: 50% • Power factor • Efficiency	0.83 74.3%	0.72 81.5%	0.72 81.5%	0.79 75.0%	0.70 85.5%	0.70 85.5%

Authorized Plymovent Distributor:

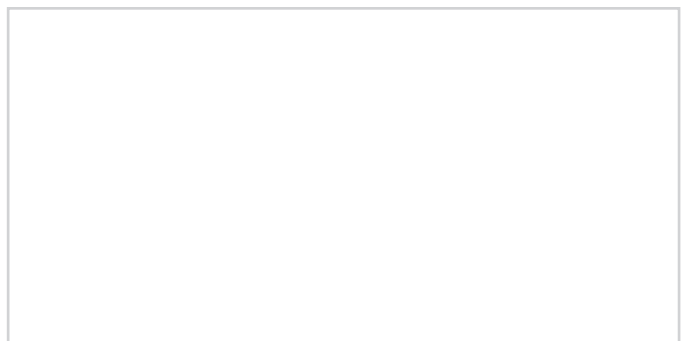

Product type	FUA (60Hz)
Article no.	Refer to tables
Product category	Extraction fans
Version	15SEP2023/I

Always check the latest version on www.plymovent.com