

TEV (60Hz)

TEV-359/3110/559/585/745/768

The TEV is a central extraction fan that is equipped with a lightweight aluminium impeller, making it suited to exhaust gases, volatile fumes and dust. Matched inlet and outlet areas, together with optimized impellers, ensure even airflow, high capacity and low noise level.

The fan is intended and designed for mounting filter units and vehicle exhaust extraction systems. The fan is rated for outdoor use.



APPLICATIONS

<p>The TEV fans are intended to be used for the following applications:</p> <ul style="list-style-type: none"> • MIG-MAG/GMAW welding • TIG welding • FCAW welding • stick/MMAW welding • vehicle exhaust extraction systems 	
<p>Do not use the TEV fans for the following applications or in the following circumstances:</p> <ul style="list-style-type: none"> • aluminium laser cutting • extraction of aggressive fumes and gases (e.g. from acids, alkaline or soldering paste containing lithium) • extraction of hot gases exceeding 176°F (80°C) continuously • grinding aluminium and magnesium • flame spraying • extraction of cement, saw dust, wood dust, etc. • explosive environments or explosive substances/gases 	

SPECIFICATIONS

■ Physical dimensions and properties	
Material:	<ul style="list-style-type: none"> • aluminum • powder coated galvanized sheet metal
Color housing	basalt gray (RAL 7011)
Motor design	NEMA
Fan type	centrifugal, up blast
Impeller	backward inclined
Discharge position	90° rotatable
Design conditions	68°F (20°C) at sea level
Max. airflow temperature	176°F (80°C) continuously
■ Performance	
Max. starts/stops per hour	20 (1ph); 30 (3ph)
■ Ambient conditions	
Operating temperature:	<ul style="list-style-type: none"> • min. -4°F (-20°C) • nom. 68°F (20°C) • max. 176°F (80°C)
Max. relative humidity	80%
Storage conditions	<ul style="list-style-type: none"> • -4 to 176°F (-20 to 80°C) • relative humidity max. 80%

■ Options and accessories

<i>Outlet transition from rectangular to round</i>	
<ul style="list-style-type: none"> • TOL-250 • TOL-315 • TOL-400/500 	<ul style="list-style-type: none"> • TEV-359/3110 • TEV-559/585 • TEV-745/768
<i>Soft connection for noise and vibration free connection to duct (to be installed with inlet and outlet transition TOL)</i>	
<ul style="list-style-type: none"> • SC-200 • SC-250 • SC-315 • SC-400 	<ul style="list-style-type: none"> • TEV-359/3110 (inlet) • TEV-359/3110 (outlet) • TEV-559/585 (inlet) • TEV-559/585 (outlet) • TEV-745/768 (inlet) • TEV-746/768 (outlet)
<i>Vibration dampers to isolate noise and vibration</i>	
<ul style="list-style-type: none"> • TEV-AV/35 • TEV-AV/79 	<ul style="list-style-type: none"> • TEV-359/3110/559/585 • TEV-745/768
<i>Set consisting of TOL, 2 x SC and TEV-AV (not available in North America)</i>	
<ul style="list-style-type: none"> • TEV-KIT/3 • TEV-KIT/5 • TEV-KIT/7 	<ul style="list-style-type: none"> • TEV-359/3110 • TEV-559/585 • TEV-745/768
■ Scope of supply	
Extraction fan	
■ Shipping data	
Number/package	1

APPROVALS/CERTIFICATES

	Compliance with CE directives
	Directive 2011/65/EC (RoHS) valid as of 8 June 2011
	Plymovent certifies that the products shown herein are licensed to bear the AMCA Seal. The ratings shown comply with the requirements of the AMCA Certified Ratings Program. Plymovent are rated AMCA type B
	Certified motor
	Certified motor

ARTICLE NUMBERS, WEIGHTS AND PACKING DIMENSIONS

Fan type	Connection voltage	Article number	Weight		Packing dimensions
			Net lbs (kg)	Gross* lbs (kg)	
TEV-359	115/208-230V/1ph/60Hz	0000102927	114.6 (52)	142 (64,4)	31.5 x 39.4 x 31.5 in. (80 x 100 x 80 cm)
	208-230/460V/3ph/60Hz	0000102928	105.8 (48)	135.6 (61,5)	31.5 x 39.4 x 31.5 in. (80 x 100 x 80 cm)
	575V/3ph/60Hz	0000102929	117.9 (53,5)	147.7 (67)	33.5 x 29.5 x 31.5 in. (85.1 x 74,9 x 80 cm)
TEV-3110	208-230/460V/1ph/60Hz	0000102930	120.2 (54,5)	134.5 (61)	31.5 x 39.4 x 31.5 in. (80 x 100 x 80 cm)
	208-230/460V/3ph/60Hz	0000102931	117.9 (53,5)	137.8 (62,5)	25.6 x 32.3 x 31.1 in. (65 x 82 x 79 cm)
	575V/3ph/60Hz	0000102932	116.4 (52,8)	140 (63,5)	33.5 x 29.5 x 31.5 in. (81,5 x 75 x 80 cm)
TEV-559	208-230/460V/1ph/60Hz	0000102933	214.7 (97,4)	238.1 (108)	31.5 x 39.4 x 37.8 in. (80 x 100 x 96 cm)
	208-230/460V/3ph/60Hz	0000102934	206.3 (93,6)	221.6 (100,5)	31.5 x 39.4 x 37.4 in. (80 x 100 x 95 cm)
	575V/3ph/60Hz	0000102935	218.3 (99)	244.3 (110,8)	33.5 x 29.5 x 37.4 in. (81,5 x 75 x 95 cm)
TEV-585	208-230/460V/1ph/60Hz	0000102936	207 (94)	237.0 (107,5)	31.5 x 39.4 x 37.8 in. (80 x 100 x 96 cm)
	208-230/460V/3ph/60Hz	0000102937	203.9 (92,5)	223.8 (101,5)	25.6 x 32.3 x 37.4 in. (65 x 82 x 95 cm)
	575V/3ph/60Hz	0000102938	192.9 (87,5)	222.7 (101)	33.5 x 29.5 x 37.4 in. (81,5 x 75 x 95 cm)
TEV-745	208-230/460V/1ph/60Hz	0000102939	330.7 (150)	363.8 (165)	31.5 x 47.2 x 49.2 in. (80 x 119,2 x 125 cm)
	208-230/460V/3ph/60Hz	0000102940	328.4 (149)	377.0 (171)	31.9 x 47.2 x 44.9 in. (81 x 119,2 x 114 cm)
	575V/3ph/60Hz	0000102941	339 (147)	353.8 (160,5)	31.9 x 47.2 x 49.2 in. (81 x 119,2 x 125 cm)
TEV-768	208-230/460V/3ph/60Hz	0000102942	392.1 (177,9)	442.0 (200,5)	31.9 x 47.2 x 49.2 in. (81 x 119,2 x 125 cm)
	575V/3ph/60Hz	0000102943	392.1 (177,9)	442.0 (200,5)	31.9 x 47.2 x 49.2 in. (81 x 119,2 x 125 cm)

*Gross weight = includes packaging



TEV fans are enclosed in a cardboard box and bolted, as well as metal strapped, to a wooden skid.

DIMENSIONS

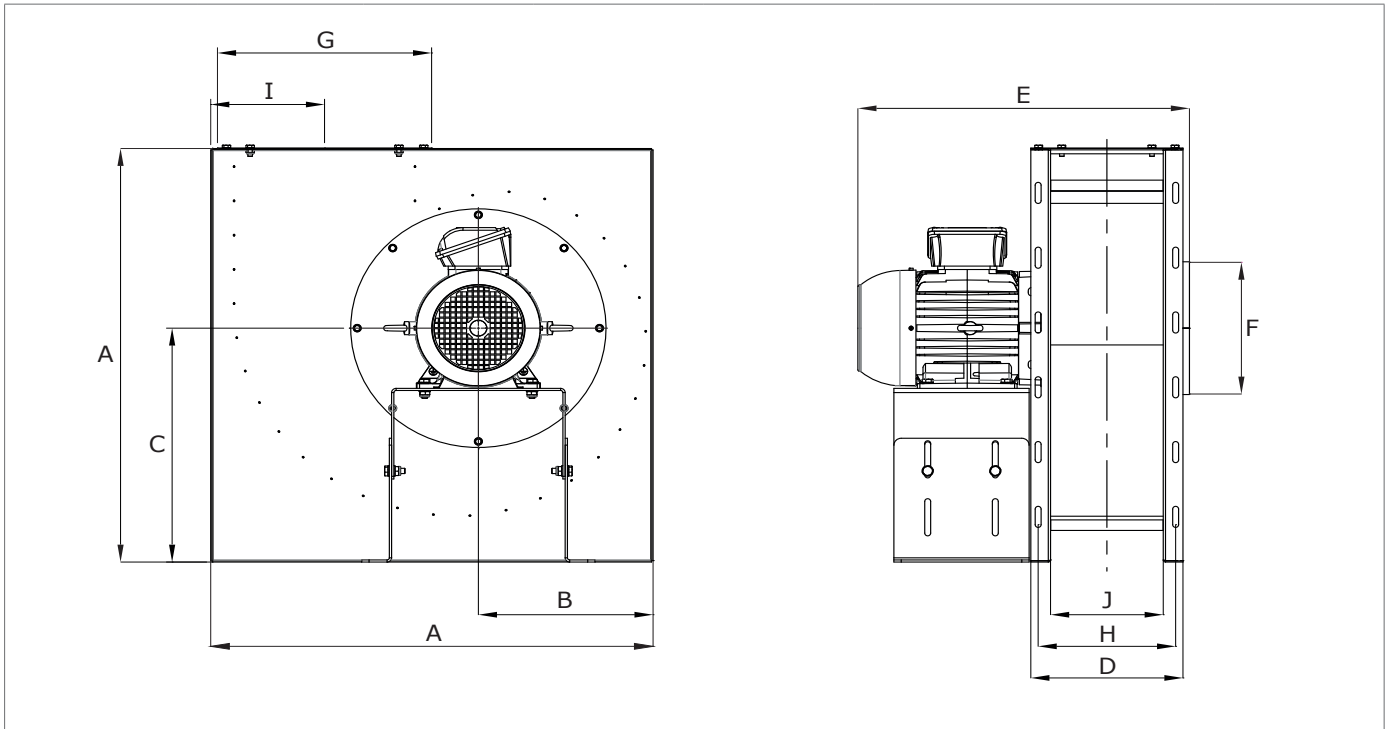

	TEV-359 TEV-3110		TEV-559 TEV-585		TEV-745 TEV-768	
	in.	mm	in.	mm	in.	mm
A	25.2	640	30.9	785	38.6	980
B	10.5	267	12.2	310	15.8	402
C	14.0	355	17.5	444	23.7	603
D	9.1	230	10.6	270	11.4	290
E	1~ motor 3~ motor	524 494	26.8 26.7	681 678	27.0 27.1	686 688
F	Ø 7.9	Ø 200	Ø 9.8	Ø 250	Ø 12.4	Ø 315
G	12.3	312	15.0	380	18.1	460
H	8.0	204	9.6	244	10.4	264
I	6.4	163	8.0	202	9.5	242
J	6.3	160	7.9	200	8.7	220

PRESSURE DROP

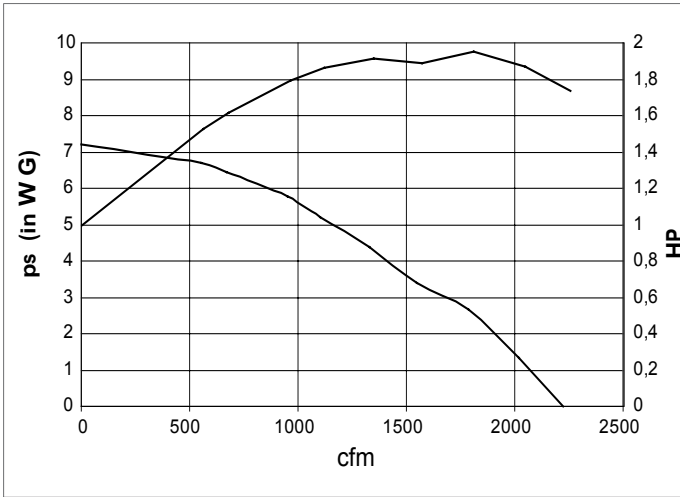

TEV-359

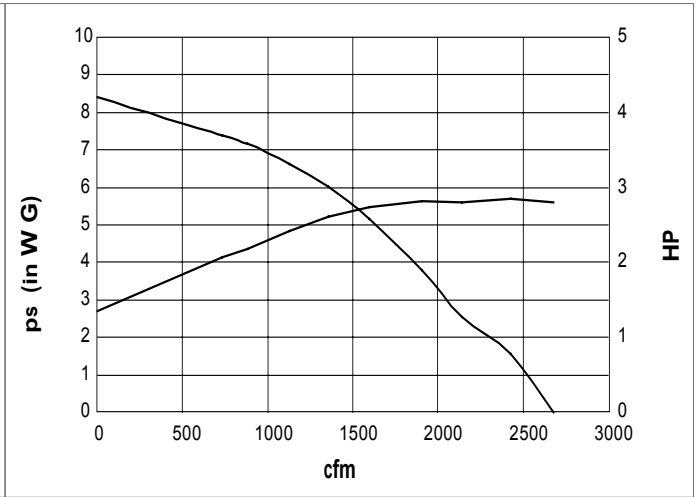

TEV-3110

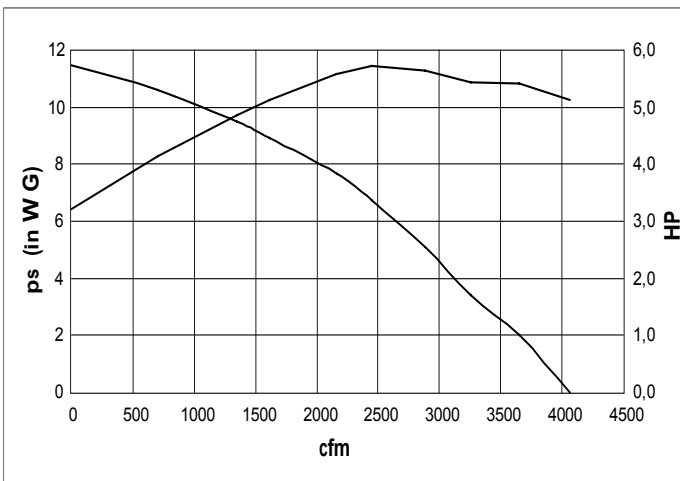

TEV-559

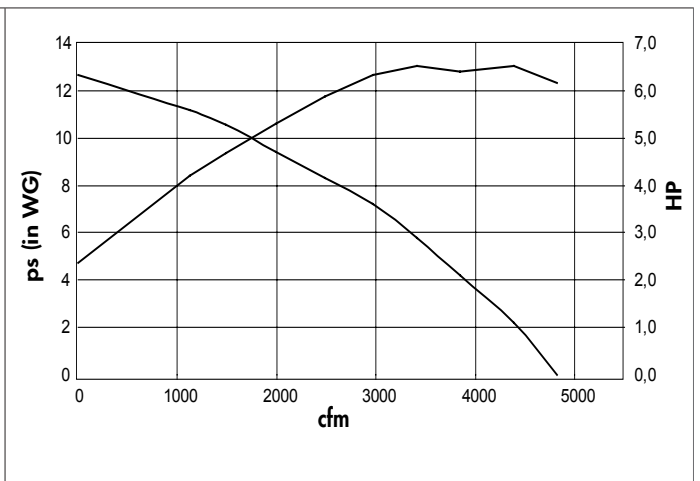

TEV-585

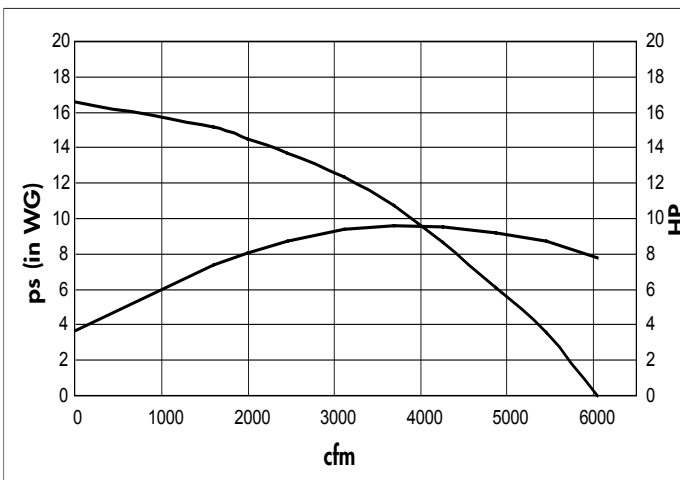

TEV-745

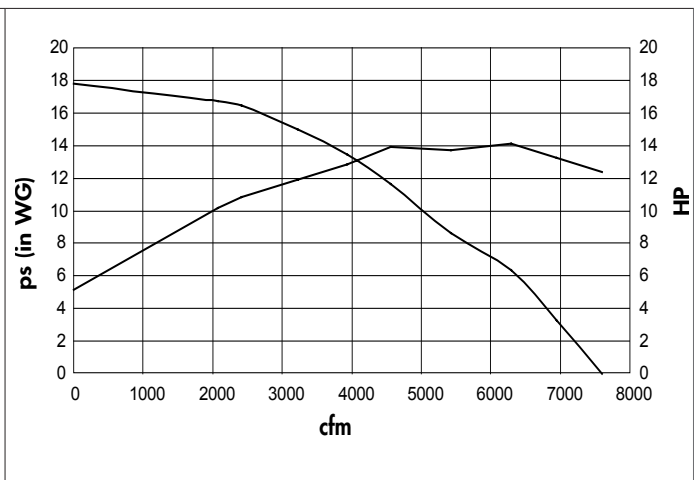

TEV-768

MOTOR SPECIFICATIONS TEV-359 | TEV-3110 | TEV-559

	TEV-359			TEV-3110			TEV-559		
Power	2 HP (1,5 kW)			3 HP (2,2 kW)			5 HP (3,7 kW)		
Energy efficiency (NEMA)	premium			premium			premium		
Rated voltage	115/208-230V	208-230/460V	575V	208-230	208-230/460V	575V	208-230	208-230/460V	575V
No. of phases	1ph	3ph	3ph	1ph	3ph	3ph	1ph	3ph	3ph
Frequency	60Hz	60Hz	60Hz	60Hz	60Hz	60Hz	60Hz	60Hz	60Hz
Frame	56C	56C	56C	145T	145T	56C	184TC	184TC	184TC
Poles	2	2	2	2	2	2	2	2	2
Rated speed	3450 rpm	3480 rpm	3600 rpm	3490 rpm	3460 rpm	3480 rpm	3500 rpm	3515 rpm	3485 rpm
Slip	Not Listed	Not Listed	3.47%	Not Listed	Not Listed	3.33%	Not Listed	Not Listed	3.19%
Rated current	20/11.4-10 A	5.2-4.8/2.4 A	3.10 A	14.38-13 A	8.8-8/4 A	3.01 A	21.89-19.8 A	13.26-12/6 A	4.72 A
L. R. Amperes	64.40 A	26.00 A @460V	16.1 A	100 A @230V	41 A @460V	25.6 A	153 A @230V	47 A @230V	35.9 A
II/In	Not Listed	Not Listed	Not Listed	7.0 Code J	8.1 Code J	8.1 Code J	7.8 Code J	7.5 Code H	7.5 Code H
No load current	94.5 A @230V	.95 A @460V	0.829 A	4.93 @230V	1.90 A @460V	1.12 A	8.00/4.00 A	4.40/2.20 A	1.76 A
Rated torque	3.00 ft-lbs (4.07 Nm)	3.02 ft-lbs (4.09 Nm)	3.02 ft-lbs (4.09 Nm)	4.5 ft-lbs (6.10 Nm)	4.55 ft-lbs (6.17 Nm)	4.55 ft-lbs (6.17 Nm)	7.52 ft-lbs (10.2 Nm)	7.52 ft-lbs (10.2 Nm)	7.52 ft-lbs (10.2 Nm)
Locked rotor torque	250%	360%	229%	302%	399%	270%	216%	213%	229%
Breakdown torque	260%	433%	380%	230%	360%	360%	260%	350%	350%
Design	L	L	A	L	B	A	L	A	B
Insulation class	F	F	F	F	F	F	F	F	F
Temperature rise	90 @100% load	46 @100% load	80 K	80 @100% Load	80 K	80 K	71 @100% Load	55 @100%	80 K
Locked rotor time	90.0 F @FL	17 s (hot)	11 s (hot)	Not Listed	Not Listed	6 s (hot)	Not Listed	Not Listed	25 s (hot)
Service factor	1	1.15	1.15	1	1.15	1.15	1.15	1.25	1.25
Duty cycle	Continuous	Continuous	Continuous	Continuous	Continuous	Continuous	Continuous	Continuous	S1
Ambient temperature	-4°F to 176°F (-20°C to +80°C)	-4°F to 176°F (-20°C to +80°C)	-4°F to 176°F (-20°C to +80°C)	-4°F to 176°F (-20°C to +80°C)	-4°F to 176°F (-20°C to +80°C)	-4°F to 176°F (-20°C to +80°C)	-4°F to 176°F (-20°C to +80°C)	-4°F to 176°F (-20°C to +80°C)	-4°F to 176°F (-20°C to +80°C)
Altitude	3280 ft (1000 m) above sea level	3280 ft (1000 m) above sea level	3280 ft (1000 m) above sea level	3280 ft (1000 m) above sea level	3280 ft (1000 m) above sea level	3280 ft (1000 m) above sea level	3280 ft (1000 m) above sea level	3280 ft (1000 m) above sea level	3280 ft (1000 m) above sea level
Enclosure	IP43 (TEFC)	IP43 (TEFC)	IP55 (TEFC)	IP55 (TEFC)	IP55 (TEFC)	IP55 (TEFC)	IP55 (TEFC)	IP55 (TEFC)	IP55 (TEFC)
Mounting	Rigid/F1	Rigid/F1	Rigid/F1	Rigid/F1	Rigid/F1	Rigid/F1	Rigid/F1	Rigid/F1	B34T
Rotation	both	both	both	both	both	both	both	both	both
Preferred preset rotation direction	CCW, seen from drive end side			CCW, seen from drive end side			CCW, seen from drive end side		
Approx. weight	45 lb (20,41 kg)	35 lb (15,88 kg)	32.3 lb (14,65 kg)	57 lb (25,85 kg)	40.5 lb (18,37 kg)	106 lb (48,08 kg)	100 lb (45,36 kg)	100 lb (45,36 kg)	Not Listed
Moment of inertia	Not Listed	Not Listed	0.0963 sq.ft. lb (0.0133 kgm ²)	Not Listed	Not Listed	0.1279 sq.ft. lb (0.0177 kgm ²)	Not Listed	Not Listed	0.2233 sq.ft.lb (0.0309 kgm ²)
Sound pressure level (global)	Not Listed	Not Listed	68.0 dB(A)	Not Listed	Not Listed	68.0 dB(A)	Not Listed	Not Listed	69.0 dB(A)
Foundation loads: • max. traction • max. compression	Not Listed	Not Listed	Not Listed	Not Listed	Not Listed	Not Listed	Not Listed	Not Listed	Not Listed
Load: 100% • Power factor • Efficiency	87.0% 73%	87.1% 88.4%	90.0% 80.0%	91.0 % 82.4 %	81.0% 86.9%	90.0% 81.5%	98% 82.5%	89.5% 88.5%	89% 88.5%
Load: 75% • Power factor • Efficiency	81.7% 72.9%	86.7 % 82.1%	86% 78.5%	88.2% 81.3%	79.2% 85.6%	86.0% 81.5%	98.1% 81.3%	87.5% 89.1%	85.0% 88.5%
Load: 50% • Power factor • Efficiency	71.8% 71%	85.5% 72.2%	76% 75.5%	81% 77.4%	67.6% 83.2%	76% 80%	97.8% 77.4%	81.1% 87.9%	76% 86.5%

MOTOR SPECIFICATIONS TEV-585 | TEV-745 | TEV-768

	TEV-585			TEV-745			TEV-768	
Power	7.5 HP (5,5 kW)			10 HP (7,5 kW)			15 HP (11 kW)	
Energy efficiency (NEMA)	premium			premium			premium	
Rated voltage	208-230V	208-230/ 460V	575V	208-230V	208-230/ 460V	575V	208-230/ 460V	575V
No. of phases	1ph	3ph	3ph	1ph	3ph	3ph	3ph	3ph
Frequency	60Hz	60Hz	60Hz	60Hz	60Hz	60Hz	60Hz	60Hz
Frame	213TC	213TC	213/5TC	215TC	215TC	213/5TC	254Tc	254/6TC
Poles	2	2	2	2	2	2	2	2
Rated speed	3465 rpm	3450 rpm	3520 rpm	3500 rpm	3535 rpm	3520 rpm	3545 rpm	3530 rpm
Slip	3.06%	3.19%	2.22%	Not Listed	Not Listed	2.22%	Not Listed	1.95%
Rated current	36-32 A	19.68-17.8/ 8.9 A	7.01 A	44-41.5 A	26.1-23.6/ 11.8 A	9.28 A	39.25- 35.5/17.8 A	13.8 A
L. R. Amperes	189 A 230V	63.5A @460V	50.5 A	249 A @230V	80A @460V	66.8 A	114 A @460V	92.2 A
ll/In	7.8 Code J	8.2 Code J	8.2 Code J	6.8 Code G	7.2 Code H	7.2 Code H	7.6 Code H	7.6 Code H
No load current	8.36 A	3.20 A @460V	2.16 A	9.00 @230V	3.5 A @460V	2.72 A	6.50 A @460V	4.80 A
Rated torque	11.30 ft-lbs (15.30 Nm)	11.10 ft-lbs (15.05 Nm)	11 ft-lbs (14.91 Nm)	15 ft-lbs (20.33 Nm)	14.9 ft-lbs (20.20 Nm)	14.7 ft-lbs (19.93 Nm)	22.2 ft-lbs (30.10 Nm)	22 ft-lbs (29.83 Nm)
Locked rotor torque	280%	270%	270%	220%	210%	210%	240%	240%
Breakdown torque	165%	216%	210%	173%	201%	220%	167%	220%
Design	L	B	B	L	B	B	B	B
Insulation class	F	F	F	F	F	F	F	F
Temperature rise	80 @100% Load	80 K	80 K	85 @100% Load; 115 @115% Load	85 @100% Load; 115 @115% Load	80 K	85 @100% Load; 115 @ 115% Load	80 K
Locked rotor time	8 s (hot)	Not Listed	Not Listed	Not Listed	Not Listed	24 s (hot)	14 s (hot)	25 s (hot)
Service factor	1	1.15	1.15	1	1.15	1.25	1.15	1.25
Duty cycle	Continuous	Continuous	Continuous	Continuous	Continuous	Continuous	Continuous	Continuous
Ambient temperature	-4°F to 176°F (-20°C to +80°C)	-4°F to 176°F (-20°C to +80°C)	-4°F to 176°F (-20°C to +80°C)	-4°F to 176°F (-20°C to +80°C)	-4°F to 176°F (-20°C to +80°C)	-4°F to 176°F (-20°C to +80°C)	-4°F to 176°F (-20°C to +80°C)	-4°F to 176°F (-20°C to +80°C)
Altitude	3280 ft (1000 m) above sea level	3280 ft (1000 m) above sea level	3280 ft (1000 m) above sea level	3280 ft (1000 m) above sea level	3280 ft (1000 m) above sea level	3280 ft (1000 m) above sea level	3280 ft (1000 m) above sea level	3280 ft (1000 m) above sea level
Enclosure	IP43 (TEFC)	IP43 (TEFC)	IP55 (TEFC)	IP43 (TEFC)	IP43 (TEFC)	IP55 (TEFC)	IP55 (TEFC)	IP55 (TEFC)
Mounting	Rigid/F1	Rigid/F1	Rigid/F1	Rigid/F1	Rigid/F1	Rigid/F1	Rigid/F1	Rigid/F1
Rotation	both	both	both	both	both	both	both	both
Preferred preset rotation direction	CCW, seen from drive end side			CCW, seen from drive end side				
Approx. weight	150 lbs (68.04 kg)	160 lbs (72.57 kg)	156 lbs (70.76 kg)	152 lbs (68.95 kg)	175 lbs (79.37 kg)	174 lbs (78.93 kg)	208 lbs (94.35 kg)	260 lbs (118 kg)
Moment of inertia	Not Listed	Not Listed	0.4665 sq.ft. lb (0.0645 kgm ²)	Not Listed	Not Listed	0.6362 sq.ft. lb (0.0880 kgm ²)	Not Listed	1.26 sq.ft.lb (0.1742 kgm ²)
Sound pressure level (global)	Not Listed	69.0 dB(A)	69.0 dB(A)	Not Listed	72.0 dB(A)	72.0 dB(A)	72.0 dB(A)	72.0 dB(A)
Foundation loads: • max. traction • max. compression	Not Listed	Not Listed	Not Listed	Not Listed	Not Listed	Not Listed	Not Listed	Not Listed
Load: 100% • Power factor • Efficiency	93.5% 81.5%	87% 92.2%	88% 89.5%	93.2% 83.8%	87% 91.7%	90% 90.2%	87% 91%	88% 91%
Load: 75% • Power factor • Efficiency	90.4% 77.8%	83% 89.5%	84% 89.5%	92.9% 83.9%	92.4% 86.9%	87% 90.2%	83.5% 91.0%	85% 91%
Load: 50% • Power factor • Efficiency	87% 80%	74.5% 86.5%	75% 87.5%	90.3% 81.3%	78.5% 91.7%	79% 89.5%	70.5% 90.6%	77% 89.5%

NOISE LEVEL

	Static pressure (in. WG)	Noise level in dB(A)			
		at 3.3 ft (1 m)	at 6.5 ft (2 m)	at 9.8 ft (3 m)	at 13.1 ft (4 m)
TEV-359	0	84	78	74	72
	1	83	77	73	71
	2	82	76	72	70
	3	82	76	72	70
	4	80	74	70	68
TEV-3110	0	87	81	77	75
	1	86	80	76	74
	2	86	80	76	74
	3	86	80	76	74
	4	86	80	76	74
TEV-559	0	88	82	78	76
	1	89	83	79	77
	2	89	83	79	77
	3	89	83	79	77
	4	88	82	78	76
	5	88	82	78	76
TEV-585	0	95	89	85	83
	1	95	89	85	83
	2	94	88	84	82
	3	94	88	84	82
	4	93	87	83	81
	5	92	86	82	80
TEV-745	0	92	86	82	80
	2	91	85	81	79
	4	90	84	80	78
	6	89	83	79	77
	8	89	83	79	77
TEV-768	0	97	91	87	85
	2	96	90	86	84
	4	95	89	85	83
	6	95	89	85	83
	8	95	89	85	83

Authorized Plymovent Distributor:

Product type	TEV (60Hz)
Article no.	refer to tables
Product category	extraction fans
Version	12DEC22/E

Always check the latest version on www.plymovent.com