

Extraction arm

## MINIMAN-75

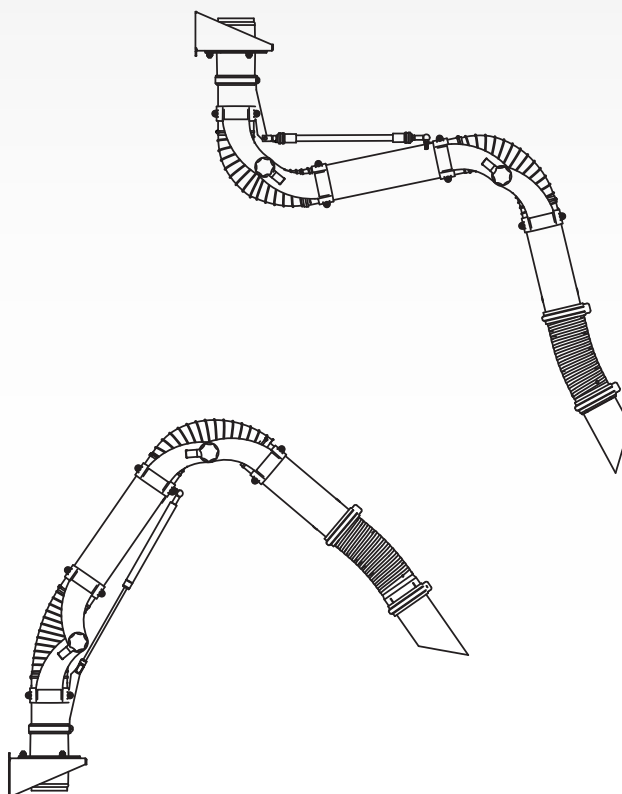

EN

Installation and user manual

---

---

## TABLE OF CONTENTS

PREFACE.....	2
1 INTRODUCTION.....	2
2 PRODUCT DESCRIPTION .....	3
3 SAFETY .....	3
4 INSTALLATION .....	4
5 USE .....	5
6 MAINTENANCE .....	5
7 TROUBLESHOOTING .....	6
8 SPARE PARTS .....	6
9 DISPOSAL .....	6

### EN | ORIGINAL INSTRUCTION

All rights reserved. The information given in this document has been collected for the general convenience of our clients. It has been based on general data pertaining to construction material properties and working methods known to us at the time of issue of the document and is therefore subject at any time to change or amendment and the right to change or amend is hereby expressly reserved. The instructions in this publication only serve as a guideline for installation, use, maintenance and repair of the product mentioned on the cover page of this document. This publication is to be used for the standard model of the product of the type given on the cover page. Thus the manufacturer cannot be held responsible for any damage resulting from the application of this publication to the version actually delivered to you. This publication has been written with great care. However, the manufacturer cannot be held responsible, either for any errors occurring in this publication or for their consequences.

*To improve comprehension for people whose first language is not English, we have written parts of this manual in Simplified Technical English (STE). STE is a controlled language originally developed for aerospace industry maintenance manuals. It offers a carefully limited and standardized subset of English, along with specific writing rules.*









## PREFACE

### Using this manual

This manual is intended to be used as a work of reference for professional, well trained and authorised users to be able to safely install, use, maintain and repair the product mentioned on the cover of this document.

### Pictograms and symbols

The following pictograms and symbols are used in this manual:

	<b>TIP</b> Suggestions and recommendations to simplify carrying out tasks and actions.
	<b>ATTENTION</b> A remark with additional information for the user. A remark brings possible problems to the user's attention.
	<b>CAUTION!</b> Procedures, if not carried out with the necessary caution, could damage the product, the workshop or the environment.
	<b>WARNING!</b> Procedures which, if not carried out with the necessary caution, may damage the product or cause serious personal injury.
	<b>WARNING!</b> Fire hazard! Important warning to prevent fire.
	<b>WARNING!</b> Explosion hazard! Important warning to prevent explosions.
	<b>Personal protective equipment (PPE)</b> Instruction to use respiratory protection when you do service, maintenance and repair jobs, as well as during functional testing. We recommend to use a half-face respirator according to EN 149:2001 + A1:2009, class FFP3 (Directive 89/686/EEC).
	<b>Personal protective equipment (PPE)</b> Instruction to use protective gloves when you do service, maintenance and repair jobs.

### Text indicators

Listings indicated by "-" (hyphen) concern enumerations. Listings indicated by "•" (bullet point) describe steps to perform.

## 1 INTRODUCTION

### 1.1 Identification of the product

The identification plate contains, among other things, the following data:

- product name
- serial number

### 1.2 General description

The MiniMan-75 is a compact flexible arm, which is ideal for all types of smaller dust and fume applications.

The arm is fitted with exterior friction joints ("ClearThru" design), which allows for maximum air velocity, low pressure drop and low noise level. The inner tubes are kept in place by a gas spring (standing arm) or a balancing strap (hanging arm). This design ensures smooth movement of the arm.

The MiniMan-75 arm is available in three different types:

- type **H**: for hanging mounting
- type **S**: for standing mounting

- type **TopGrade**: white arm (hanging or standing), especially suitable for use in clean working environments, such as laboratories

### 1.3 Options and accessories

DAMPER-75	Sealed shut-off valve
MM-001	Round extraction hood (Ø 150 mm / 5 7/8 in.)
MM-004	Transparent dome hood (Ø 385 mm / 15 1/8 in.)
MM-005	Table bracket (only for MiniMan <b>S</b> types)

### 1.4 Product combinations

You can use the MiniMan-75 with the following products:

Extraction fan	Suitable for
- FUA-1800   0,55 kW (¾ HP)	- 3-4 MiniMan arms
- FUA-2100   0,75 kW (1 HP)	- 5-6 MiniMan arms
- FUA-3000   1,1 kW (1½ HP)	- 9-10 MiniMan arms
- FUA-4700   2,2 kW (3 HP)	- 15-16 MiniMan arms
Stanchion	
- PA-110/160   1,1 m (3 5/8 ft)	
- PA-220-160   2,2 m (7 ¼ ft)	

### 1.5 Technical specifications

Physical dimensions and properties	
Length (nom.):	
- MM-75-1.0	- 1 m (3 ft.)
- MM-75-1.5	- 1,5 m (5 ft.)
Diameter	Ø 75 mm (3 in.)
Material:	
- tubes	- aluminium
- hoses	- PVC with internal steel spiral; flame-retardant
Weight (net):	
- MM-75-1.0	- 4 kg (9 lbs.)
- MM-75-1.5	- 4,5 kg (10 lbs.)
Performance	
Recommended airflow	100-250 m³/h (59-147 CFM)
- min. airflow	- 100 m³/h (59 CFM)

### 1.6 Working reach

Refer to Fig. I on page 7.

### 1.7 Pressure drop

Refer to Fig. II on page 7.

	Refer to the available product data sheet for detailed product specifications.
---	--

### 1.8 Ambient and process conditions

Process temperature:	
- min.	5°C (41°F)
- nom.	20°C (68°F)
- max.	70°C (158°F)
Max. relative humidity	90%
Outdoor use allowed	no

## 2 PRODUCT DESCRIPTION

### 2.1 Components

The product consists of the following main components and elements:

Fig. 2.1

- A Mounting bracket
- B Friction joint (2)
- C Hose (2)
- D Balancing strap
- E Inner tube
- F Outer tube
- G Semi rigid hose
- H Nozzle
- I Gas spring

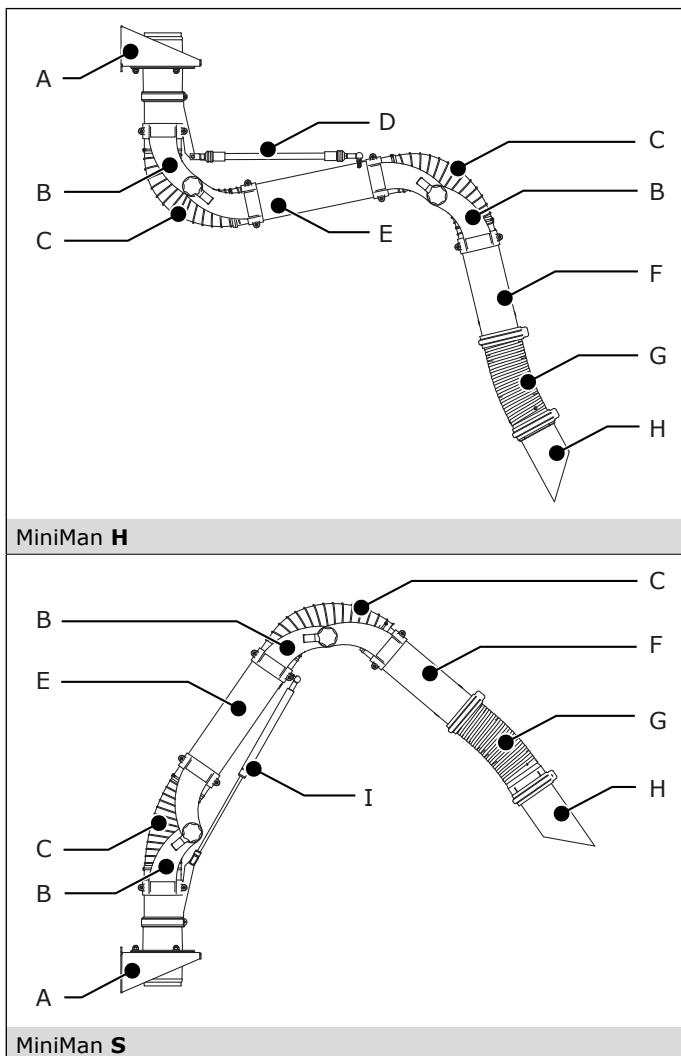

Fig. 2.1 Main components and elements

### 2.2 Operation

The fume is extracted through the nozzle of the arm by an extraction fan. The extraction arm discharges the polluted air to an extraction duct with filter unit or directly to the atmosphere.

#### 2.2.1 Option: DAMPER-75 (sealed shut-off valve)

It is possible to install a valve to shut off or regulate the airflow. The shut-off valve is mostly used when several extraction arms are integrated in a line installation with exhaust to the atmosphere; in such configurations closing the valve prevents the loss of costly heated air. You can also use

the valve to prevent fume from escaping through the nozzle when the extraction fan is off.

## 3 SAFETY

### General

The manufacturer does not accept any liability for damage to the product or personal injury caused by ignoring of the safety instructions in this manual, or by negligence during installation, use, maintenance, and repair of the product mentioned on the cover of this document and any corresponding accessories. Specific working conditions or used accessories may require additional safety instructions. Immediately contact your supplier if you detect a potential danger when using the product.



**The user of the product is always fully responsible for observing the local safety instructions and regulations. Observe all applicable safety instructions and regulations.**

### User manual

- Everyone working on or with the product, must be familiar with the contents of this manual and must strictly observe the instructions therein. The management should instruct the personnel in accordance with the manual and observe all instructions and directions given.
- Do not change the order of the steps to perform.
- Keep the manual with the product.

### Users

- The use of this product is exclusively reserved to authorised, trained and qualified users. Temporary personnel and personnel in training can only use the product under supervision and responsibility of skilled engineers.
- Stay alert and keep your attention to your work. Do not use the product when you are under the influence of drugs, alcohol or medicine.
- The product is not to be used by children or persons with reduced physical, sensory or mental capabilities, or lack of experience and knowledge, unless they have been given supervision or instruction.
- Children must be supervised not to play with the product.

### Intended use<sup>1</sup>

The product has been designed exclusively for extracting soldering fumes, airborne dust and fumes from solvents. The TopGrade type of arm (fully white) is especially suitable for use in laboratories in the pharmaceutical, chemical and food processing industry. Using the product for other purposes is considered contrary to its intended use. The manufacturer accepts no liability for any damage or injury resulting from such use. The product has been built in accordance with state-of-the-art standards and recognised safety regulations. Only use this product when in technically perfect condition in accordance with its intended use and the instructions explained in the user manual.

### Technical specifications

Do not change the specifications given in this manual.

### Modifications

Modification of (parts of) the product is not allowed.

1. "Intended use" as explained in EN-ISO 12100-1 is the use for which the technical product is suited as specified by the manufacturer, inclusive of his directions in the sales brochure. In case of doubt it is the use which can be deduced from the construction, the model and the function of the technical product which is considered normal use. Operating the machine within the limits of its intended use also involves observing the instructions in the user manual.



## Product combinations

If the product is used in combination with other products or machines, the safety instructions in the documentation of these products also apply.

## Installation

- The installation of this product is exclusively reserved to authorised, trained and qualified engineers.
- During installation, always use Personal Protective Equipment (PPE) to avoid injury. This also applies to persons who enter the work area during installation.
- Use sufficient climbing gear and safety guards when working on a higher level than 2 metres (local restrictions may apply).
- Do not install the product in front of entrances and exits which must be used for emergency services.
- Mind any gas and water pipes and electric cables.
- Make sure that the workspace is well illuminated.
- Stay alert and keep your attention to your work. Do not install the product when you are under the influence of drugs, alcohol or medicine.
- Air containing particles such as chromium, nickel, beryllium, cadmium, lead etc., should never be recycled. This air must always be brought outside the working area.

## Use



	<b>WARNING!</b> Fire hazard! Do <b>not</b> use the product in combination with a filter for: <ul style="list-style-type: none"><li>- polishing applications in combination with grinding, welding or any other application that generate sparks (fibers from polishing or abrasive flap disks are highly flammable and pose a high risk of filter fires when exposed to sparks)</li><li>- arc-air gouging</li><li>- extracting flammable, glowing or burning particles or solids or liquids</li><li>- extracting of aggressive fumes (such as hydrochloric acid) or sharp particles</li><li>- extracting dust particles which are released when welding surfaces treated with primer</li><li>- sucking cigarettes, cigars, oiled tissues, and other burning particles, objects, and acids</li></ul>
	<b>WARNING!</b> Explosion hazard! Do <b>not</b> use the product for explosion-hazardous applications, e.g.: <ul style="list-style-type: none"><li>- aluminium laser cutting</li><li>- grinding aluminium and magnesium</li><li>- explosive environments or explosive substances/gases</li></ul>
	<b>WARNING!</b> Do <b>not</b> use the product for: <ul style="list-style-type: none"><li>- extraction of hot gases (more than 70°C/158°F continuously)</li><li>- flame spraying</li><li>- oil mist</li><li>- heavy oil mist in welding fume</li><li>- extraction of cement, saw dust, wood dust etc.</li></ul>

- Inspect the product and check it for damage. Verify the functioning of the safety features.
- During use, always use Personal Protective Equipment (PPE) to avoid injury. This also applies to persons who enter the work area.
- Check the working environment. Do not allow unauthorised persons to enter the working environment.

- Protect the product against water and humidity.
- Make sure the room is always sufficiently ventilated; this applies especially to confined spaces.
- Make sure that the workshop, in the vicinity of the product, contains sufficient approved fire extinguishers (suitable for fire classes ABC).

## Service, maintenance and repairs

- Obey the maintenance intervals given in this manual. Overdue maintenance can lead to high costs for repair and revisions and can render the guarantee null and void.
- Always use Personal Protective Equipment (PPE) to avoid injury. This also applies for persons who enter the work area.
- Make sure the room is sufficiently ventilated.
- Use tools, materials, lubricants and service techniques which have been approved by the manufacturer. Never use worn tools and do not leave any tools in or on the product.
- Safety features which have been removed for service, maintenance or repairs, must be put back immediately after finishing these jobs and it must be checked that they still function properly.
- Use sufficient climbing gear and safety guards when working on a higher level than 2 metres (local restrictions may apply).
- Clean the area afterwards.

	<b>ATTENTION</b> Service, maintenance and repairs must be performed in accordance with directive TRGS 560 and TRGS 528 by authorised, qualified and trained persons (skilled) using appropriate work practices.
	<b>Personal protective equipment (PPE)</b> Wear respiratory protection and protective gloves during service, maintenance and repairs.

## 4 INSTALLATION

### 4.1 Tools and requirements

You need the following tools and requirements to install the product:

- basic tools



### 4.2 To be sourced locally

You need the following material to install the product:

- wall mounting hardware<sup>2</sup>



### 4.3 Unpacking

Make sure that the product is complete. The package contains:

- extraction arm, incl. mounting bracket (fully assembled)



If parts are missing or damaged, contact your supplier.

### 4.4 Installation height

You can install the MiniMan arm at any desired height. For mounting examples, refer to page 8;

- Fig. III: "H" types
- Fig. IV: "S" types

2. The type of hardware depends on the wall type

## 4.5 Mounting



### PA | Stanchion

To install the MiniMan-75 on a stanchion, refer to the instruction sheet that is supplied with the PA. Refer to the available product data sheet for mounting examples.

The package contains no mounting hardware for the mounting bracket, since the required mounting hardware depends on the wall type.



### WARNING!

Before you install the product, make sure that the wall or mounting structure is strong enough. Refer to § 1.5 for the weight of the product.

### 4.5.1 Mounting bracket

Fig. 4.2

- Determine the desired installation height.
- Install the mounting bracket (including the arm) to the wall or mounting structure.

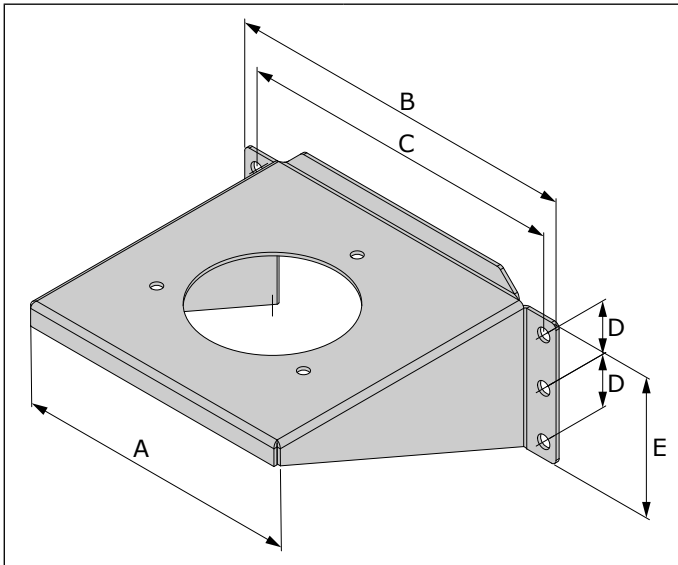

	mm	in.
<b>A</b>	162	6 <sup>3</sup> / <sub>8</sub>
<b>B</b>	202	8
<b>C</b>	186	7 <sup>3</sup> / <sub>8</sub>
<b>D</b>	30	1 <sup>1</sup> / <sub>8</sub>
<b>E</b>	79	3 <sup>1</sup> / <sub>8</sub>

Fig. 4.2 Mounting bracket

## 5 USE



### Personal protective equipment (PPE)

During use, use PPE to avoid injury. This also applies for persons who enter the work area.

Fig. 5.1

- Take the nozzle (A) to position it at max. 225 mm (9 in.) above the source of pollution.
- Make sure that the DAMPER-75 (shut-off valve), if any, is open.
- Turn on the connected extraction fan or system.
- Start working.
- If desired, partly close the valve to adjust the airflow.
- When the working position changes, move the nozzle to the correct position in relation to the workpiece.
- Turn off the connected extraction fan or system approx. 20 seconds after finishing the work.

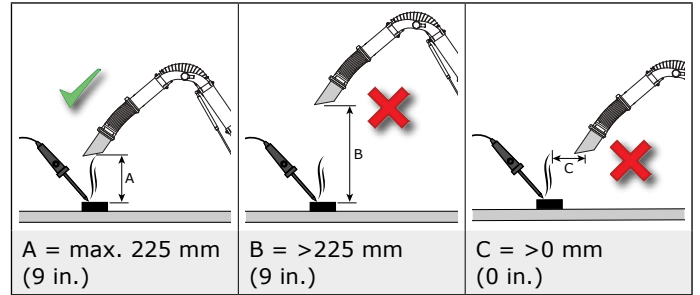

Fig. 5.1 A = Correct position of the nozzle (example: soldering)

## 6 MAINTENANCE

### 6.1 Periodic maintenance



The product has been designed to function without problems for a long time with a minimum of maintenance. In order to guarantee this some simple, regular maintenance and cleaning activities are required which are described in this chapter. If you observe the necessary caution and carry out the maintenance at regular intervals, any problems occurring will be detected and corrected before they lead to a total breakdown.



### WARNING!

Overdue maintenance can cause fire.

The indicated maintenance intervals can vary depending on the specific working and ambient conditions. Therefore we recommend to thoroughly inspect the complete product once every year beside the indicated periodic maintenance. For this purpose contact your supplier.

Component	Action	Frequency: every X months	
		X=3	X=6
Outside of the arm	Clean with a non-aggressive detergent	X	
Flexible hoses	Check for cracks or damages. Replace if necessary		X
Inside of the arm	Clean thoroughly		X
Arm movement	Check the movement of the arm. If necessary, adjust the friction; refer to § 6.2		X

## 6.2 Arm adjustment

If the extraction arm, or a part of it, does not stay in the desired position, you must adjust the friction.

Fig. 6.1

- Determine which part of the arm needs more or less friction;
  - inner tube (ref. Fig. 2.1E): adjust friction joint A
  - outer tube (ref. Fig. 2.1F): adjust friction joint B

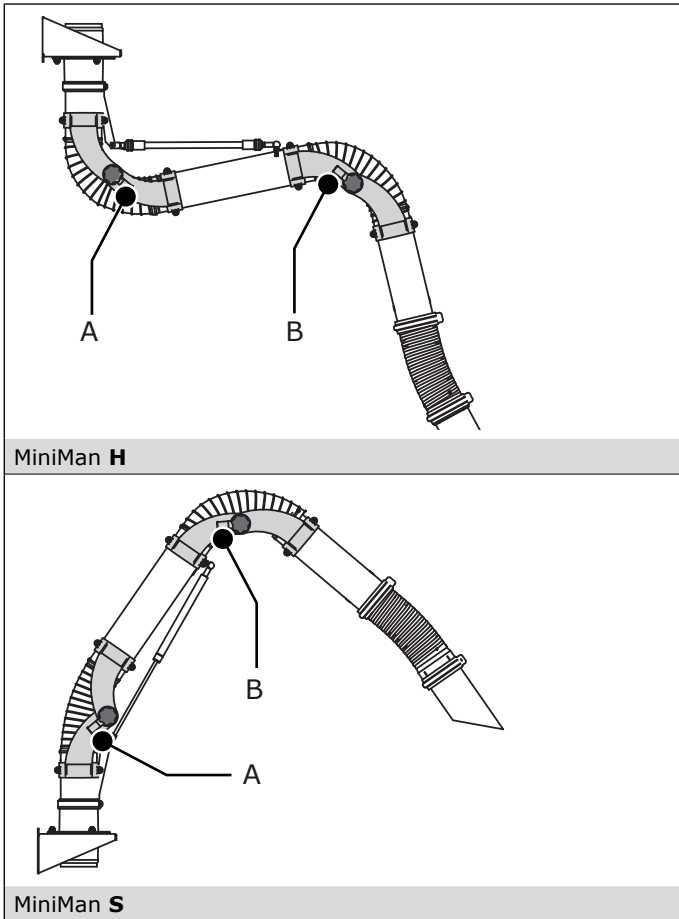

Fig. 6.1 Adjustment points

## 8 SPARE PARTS

The following spare parts are available for the product;  
- refer to exploded view Fig. V on page 9



## 9 DISPOSAL

After life of the product, dispose of it in accordance with federal, state or local regulations.



## 7 TROUBLESHOOTING

If the product does not function (correctly), consult the checklist below to see if you can remedy the error yourself. Should this not be possible, contact your supplier.



### WARNING!

Obey the safety regulations that are written in chapter 3 when you carry out the activities below.

Symptom	Problem	Possible cause	Solution
The extraction arm does not stay in the desired position	Escape of fume or dust; no proper extraction	Friction setting is not correct	Adjust the friction; refer to § 6.2
You cannot get the arm in the desired position			
Escape of fume or dust; insufficient extraction	No proper extraction	Loose hose(s)	Fasten the hose(s) properly
		Hose damage	Replace the hose(s)

Fig. I Working reach

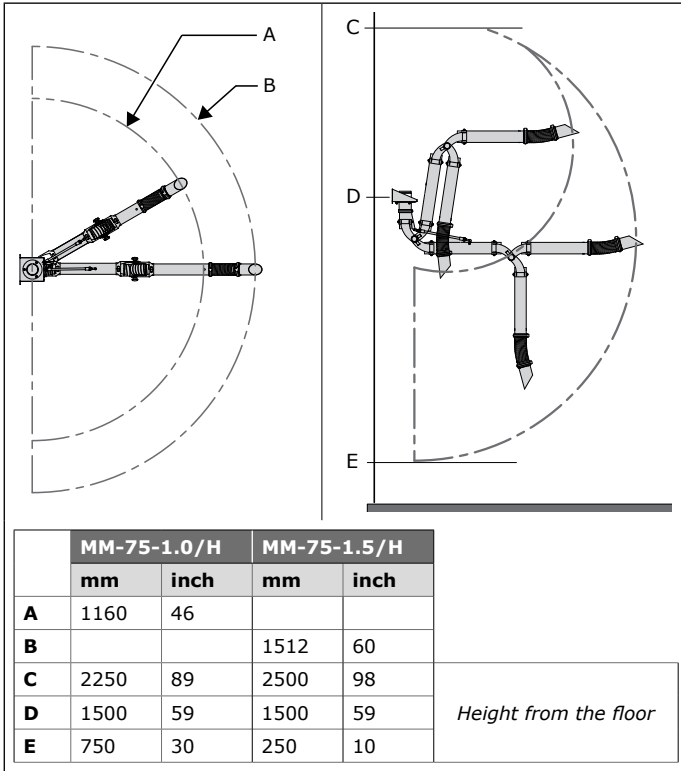

Fig. II Pressure drop

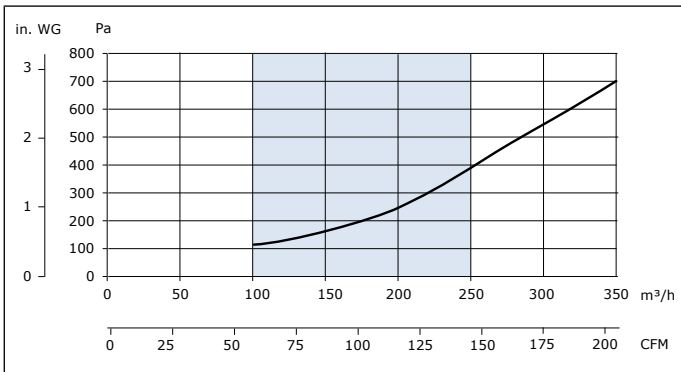



Fig. III Mounting examples MiniMan H

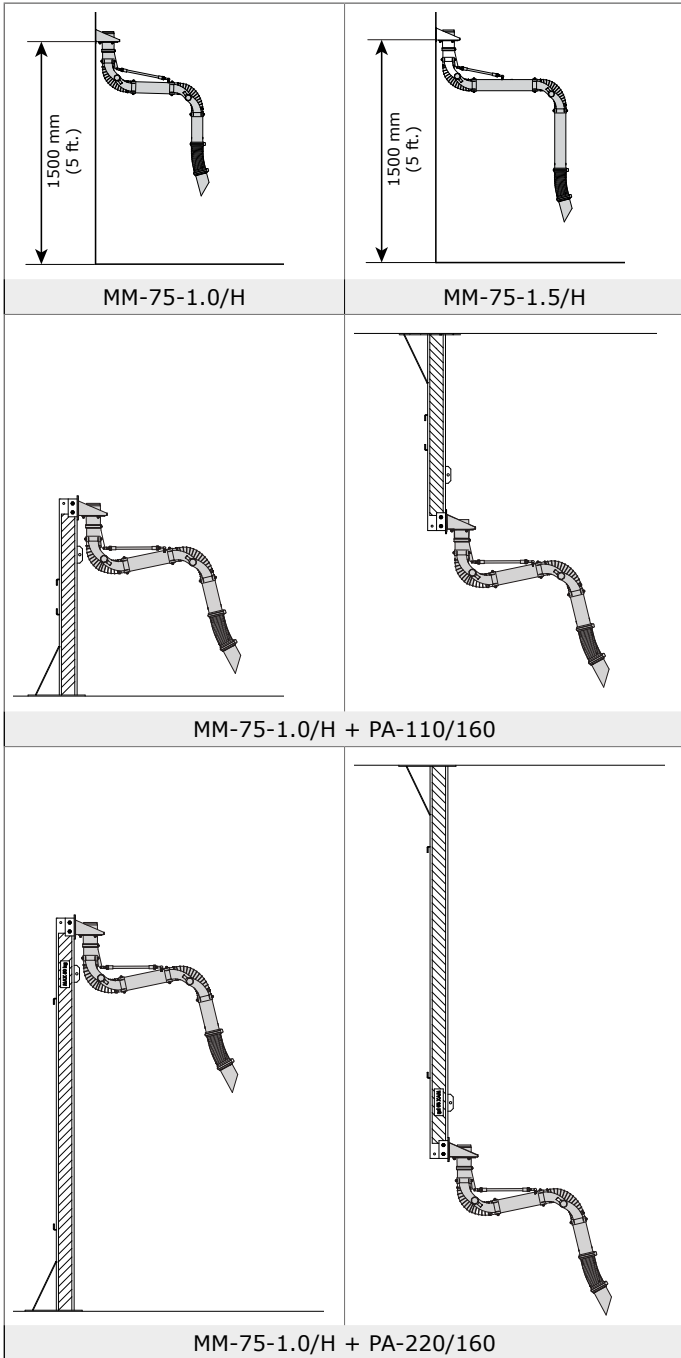

Fig. IV Mounting examples MiniMan S

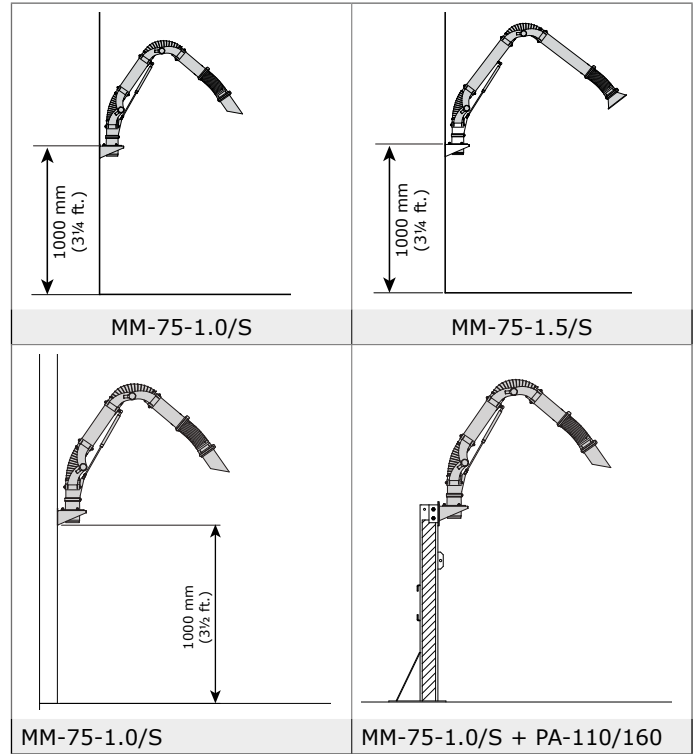
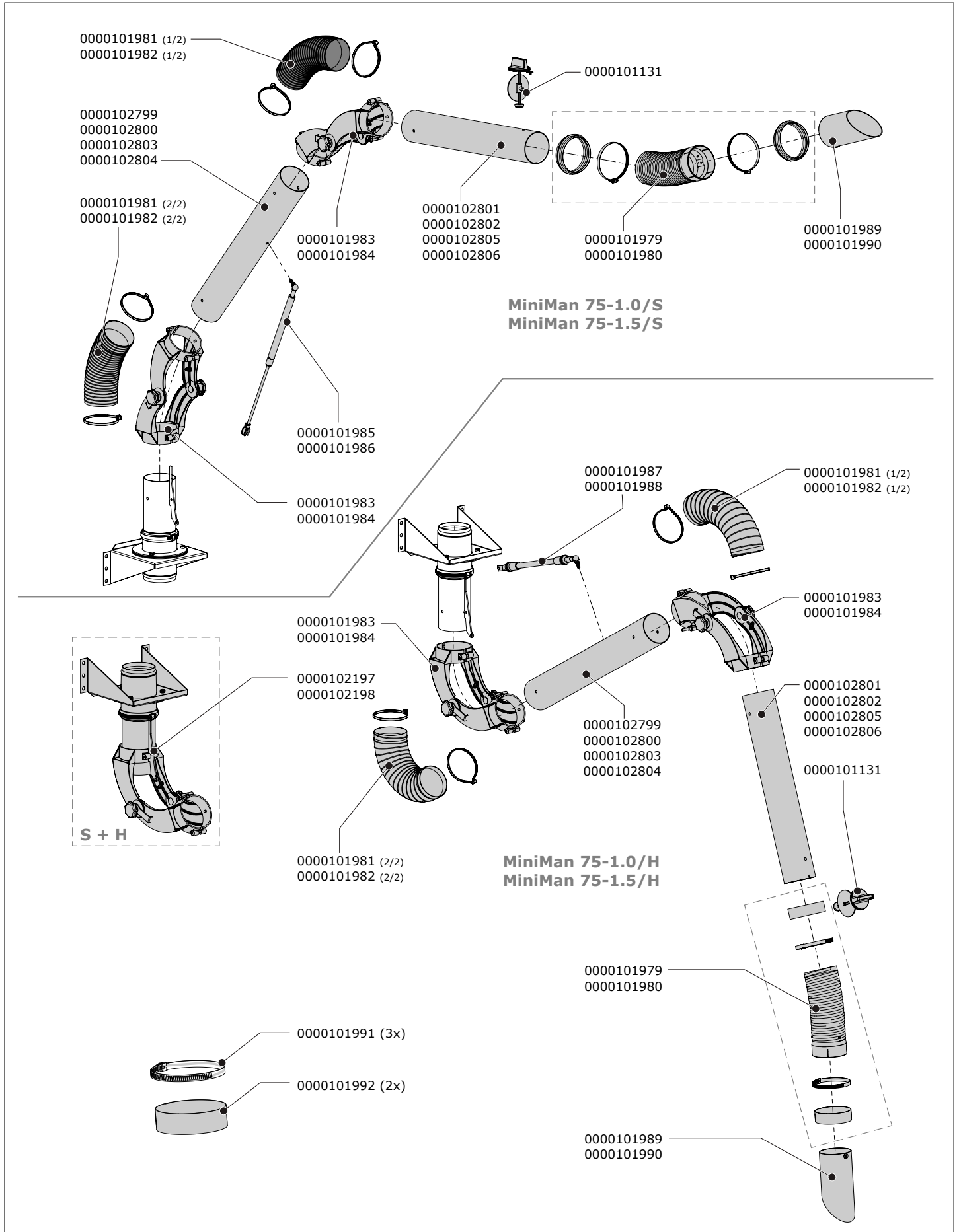

Fig. V Exploded view



Article no.	Description
<b>General</b>	
0000101131	DAMPER-75
0000101979	Semi rigid hose Ø 75 mm (black), incl. collar (2) and hose clamp (2)
0000101980	Semi rigid hose Ø 75 mm (white), incl. collar (2) and hose clamp (2)
0000101981	Hose (2) L=320 mm/Ø 75 mm (black), incl. tie-wrap (4)
0000101982	Hose (2) L=320 mm/Ø 75 mm (white), incl. tie-wrap (4)
0000101983	Joint MM-75 (black)
0000101984	Joint MM-75 (white)
0000101989	Nozzle MM-75 (black)
0000101990	Nozzle MM-75 (white)
0000101991	Hose clamp Ø 85 mm (3)
0000101992	Rubber seal 50 mm (2)
0000102197	Mounting bracket, incl. joint MM-75 (black)
0000102198	Mounting bracket, incl. joint MM-75 (white)
<b>• MM-75-1.0/H</b>	
0000101987	Balancing strap MM-75-1.0/H
0000102799	Inner tube MM-75-1.0 (white)
0000102800	Inner tube MM-75-1.0 (yellow)
0000102801	Outer tube MM-75-1.0 (white)
0000102802	Outer tube MM-75-1.0 (yellow)
<b>• MM-75-1.5/H</b>	
0000101988	Balancing strap MM-75-1.5/H
0000102803	Inner tube MM-75-1.5 (white)
0000102804	Inner tube MM-75-1.5 (yellow)
0000102805	Outer tube MM-75-1.5 (white)
0000102806	Outer tube MM-75-1.5 (yellow)
<b>• MM-75-1.0/S</b>	
0000101985	Gas spring 120 N
0000102799	Inner tube MM-75-1.0 (white)
0000102800	Inner tube MM-75-1.0 (yellow)
0000102801	Outer tube MM-75-1.0 (white)
0000102802	Outer tube MM-75-1.0 (yellow)
<b>• MM-75-1.5/S</b>	
0000101986	Gas spring 300 N
0000102803	Inner tube MM-75-1.5 (white)
0000102804	Inner tube MM-75-1.5 (yellow)
0000102805	Outer tube MM-75-1.5 (white)
0000102806	Outer tube MM-75-1.5 (yellow)

